

# Shark®

**Floor and Handheld  
Steam Cleaner**

**S6005UK**

---

**INSTRUCTIONS**



sharkclean.eu



0800 862 0453

# THANK YOU

for purchasing the Shark® Floor and Handheld Steam Cleaner



**TIP:** The QR Code can be found on the back panel of the Steam Cleaner.

## REGISTER YOUR PURCHASE

- registryyourshark.eu
- 0800 862 0453
- Scan QR code using mobile device

## RECORD THIS INFORMATION

Model Number: \_\_\_\_\_  
Date Code: \_\_\_\_\_  
Date of Purchase (Keep receipt): \_\_\_\_\_  
Store of Purchase: \_\_\_\_\_

## TECHNICAL SPECIFICATIONS

Voltage: 220-240V~, 50-60Hz  
Watts: 1200W  
Water Capacity: 500ml

## PLEASE READ CAREFULLY AND KEEP FOR FUTURE REFERENCE.

This instruction manual is designed to help you get a complete understanding of your new Steam Cleaner. If you have any questions, please call the Customer Service line at 0800 862 0453.



# CONTENTS

<b>Important Safety Instructions</b> .....	<b>3</b>
<b>Getting Started</b> .....	<b>5</b>
<b>Assembling Your Steam Cleaner</b> .....	<b>7</b>
<b>Using Your Steam Cleaner</b> .....	<b>9</b>
<b>Intelligent Steam Control®</b> .....	<b>11</b>
<b>Above-Floor Cleaning</b> .....	<b>12</b>
<b>Using the Garment Steamer</b> .....	<b>13</b>
<b>Using the Accessory Hose and the Small Above-Floor Pocket Tool</b> .....	<b>14</b>
<b>Caring For Your Steam Cleaner</b> .....	<b>15</b>
<b>Ordering Additional Accessories</b> .....	<b>17</b>
<b>Troubleshooting Guide</b> .....	<b>18</b>
<b>Frequently Asked Questions</b> .....	<b>19</b>
<b>Warranty</b> .....	<b>20</b>

This appliance complies with the WEEE-Directive 2012/19/EU on the disposal of electrical and electronic equipment (WEEE).

This marking indicates that this product should not be disposed with other household wastes throughout the EU. To prevent possible harm to the environment or human health from uncontrolled waste disposal, recycle it responsibly to promote the sustainable reuse of material sources. To return your used device, please use the return and collection systems or contact the retailer where this product was purchased. They can take this product for environmental safe recycling.



This appliance complies with the European directives for electromagnetic compatibility (EMC) 2014/30/EU and its revisions, as well as Low Voltage Directive (LVD) 2014/35/EU and its revisions.

Thank you for purchasing the Shark® Floor and Handheld Steam Cleaner Steam Cleaner. This Owner's Guide is designed to help you get a complete understanding of your new Floor and Handheld Steam Cleaner. Please read it carefully and keep for future reference. For a list of what is included with this model, refer to inside flap of box.

If you should have a question about your Shark® Floor and Handheld Steam Cleaner please call Shark® Customer Service at 0800 862 0453.

The Shark® Floor and Handheld Steam Cleaner is a complete solution for both deep steam cleaning and quick everyday cleaning. Whether you need to clean up tough stains with the Steam Blaster™ or need to quickly handle a spill, our next-generation Klik 'n' Flip® Mop Head and Dirt Grip™ Pads work with the Steam Cleaner to offer the ultimate in versatility and efficiency, making cleaning simple, quick and easy.

# IMPORTANT SAFETY INSTRUCTIONS

FOR HOUSEHOLD USE ONLY

## WARNING

To reduce the risk of injury, fire, electric shock and property damage resulting from improper use of the appliance, carefully observe the following instructions. This unit contains electrical connections and moving parts that potentially present risk to the user.



**DANGER OF SCALDING: THE STEAM EMITTED FROM THE STEAM CLEANER IS VERY HOT AND MAY CAUSE SCALDING. PLEASE USE CAUTION WHEN USING THE STEAM CLEANER.**

- 1 This appliance can be used by persons with reduced physical, sensory or mental capabilities or lack of experience and knowledge if they have been given supervision or instruction concerning use of the appliance in a safe way and understand the hazards involved. Cleaning and user maintenance shall not be made by children. Keep the appliance and its cord out of reach of children. Do not allow the appliance to be used by children. **DO NOT** allow to be used as a toy. Close supervision is necessary when used near children.
- 2 Keep the appliance out of reach of children when it is energised or cooling down.
- 3 When in use, **NEVER** turn the Steam Cleaner over on its side or direct steam toward people, pets or plants. Liquid or steam must not be directed towards equipment containing electrical components, such as the interior of ovens.
- 4 The filling aperture should not be opened during use.
- 5 Use the system **ONLY** for its intended purpose.
- 6 **DO NOT** use to heat a room.
- 7 **DO NOT** use outdoors.
- 8 **DO NOT** leave the Steam Cleaner unattended when plugged in. **ALWAYS** unplug the power cord from the electrical socket when not in use and before servicing.
- 9 **DO NOT** allow the Steam Cleaner to be used by children. Close attention is necessary when used near children, pets or plants.
- 10 Use **ONLY** as described in this instruction manual.
- 11 Use **ONLY** manufacturer's recommended accessories.
- 12 **DO NOT** use with damaged cord or plug. If the Steam Cleaner is not working as it should or has been dropped, damaged, left outdoors or immersed in water, return it to SharkNinja Operating LLC for examination and repair. Incorrect reassembly or repair can cause a risk of electrical shock or injury when the Steam Cleaner is used.
- 13 To protect against a risk of electric shock, **DO NOT** immerse the Steam Cleaner in water or any other liquid.
- 14 **DO NOT** handle the plug or Steam Cleaner with wet hands or operate it without wearing shoes.

# SAVE THESE INSTRUCTIONS

PLEASE READ CAREFULLY BEFORE USE

- 15 **DO NOT** pull or carry by cord, use cord as a handle, close a door on cord or pull cord around sharp edges or corners. **DO NOT** run Steam Cleaner over cord. Keep cord away from heated surfaces.
- 16 **DO NOT** unplug by pulling on power cord. To unplug, grasp the plug, not the power cord. **DO NOT** use extension cords or sockets with inadequate current-carrying capacity.
- 17 **DO NOT** put any objects into the steam nozzle openings. Discontinue use if the steam nozzle is blocked.
- 18 **DO NOT** put hands or feet under the Steam Cleaner. It gets very hot.
- 19 Use the floor mop **ONLY** on flat, horizontal surfaces. **DO NOT** use on walls, counters or windows.
- 20 **DO NOT** use on leather, wax-polished furniture, synthetic fabrics, velvet or other delicate, steam-sensitive materials.
- 21 **DO NOT** add cleaning solutions, vinegar, scented perfumes, oils or any other chemicals to the water used in the Steam Cleaner as this may damage it or make it unsafe for use. If you live in a hard-water area, we recommend using distilled water in your Steam Cleaner.
- 22 **NEVER** store or leave Steam Cleaner in one spot with Dirt Grip™ pad attached, as this may damage surfaces.
- 23 Before removing Dirt Grip™ pad, unplug the Steam Cleaner and allow it to cool.
- 24 Unplug the Steam Cleaner before cleaning. Use a dry or damp cloth to clean the exterior. **DO NOT** pour water on Steam Cleaner or use alcohol, benzene or paint thinner to clean.
- 25 Extreme caution should be exercised when using the Steam Cleaner to clean stairs.
- 26 **NEVER** use Steam Cleaner without the Dirt Grip™ pad attached.
- 27 Keep your work area well lit.
- 28 Store Steam Cleaner indoors in a cool, dry place.
- 29 To avoid circuit overload, **DO NOT** operate another appliance on the same socket (circuit) as the Steam Cleaner.
- 30 To avoid scalding injuries, **ALWAYS** unplug the Steam Cleaner and allow it to cool before removing or changing mop heads, accessories or Dirt Grip™ pads.
- 31 Your Steam Cleaner is designed to clean hard floor surfaces that will withstand high heat. **DO NOT** use on unsealed wood or unglazed ceramic floors. On surfaces that have been treated with wax and on some no-wax floors, the sheen may be removed by the heat and steam action. We recommend testing an isolated area of the surface to be cleaned before proceeding. We also recommend that you check the use and care instructions from the floor manufacturer.

# GETTING STARTED

## WELCOME!

Congratulations on your purchase. Use this instruction manual to learn about your new Steam Cleaner's great features. From assembly to use to maintenance, you will find it all in here.

**NOTE:** When assembling your Steam Cleaner there may be a little water in or around the water tank. This is because we test all our Steam Cleaners before you buy them.

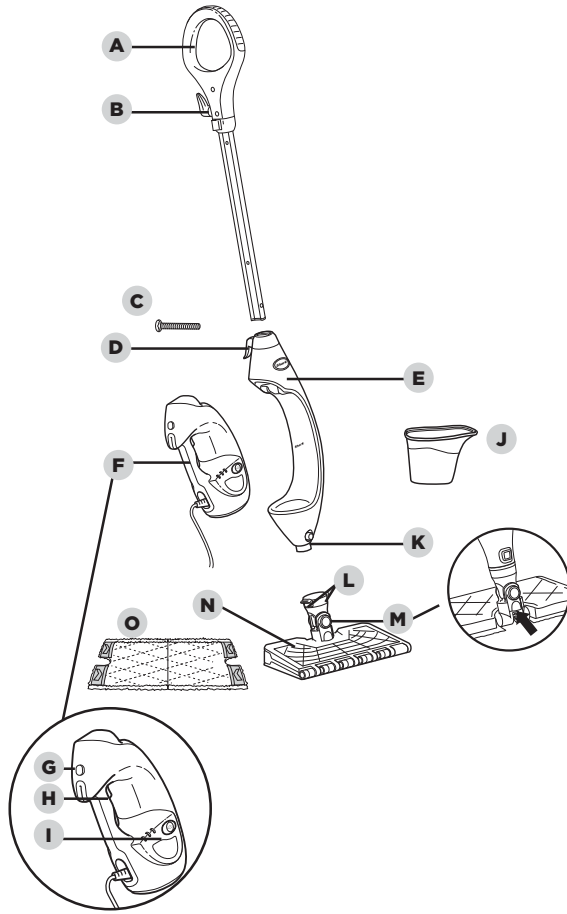

- |  |  |   |
|--|--|---|
| <b>A</b> Steam Cleaner Handle          | <b>F</b> Removable Handheld Steamer          | <b>K</b> Mop Head Release Button        |
| <b>B</b> Upper Cord Wrap               | <b>G</b> Release Button for Handheld Steamer | <b>L</b> Dirt Grip™ Pad Release Buttons |
| <b>C</b> (1) 6 mm x 54 mm Large Screw* | <b>H</b> Steam Trigger                       | <b>M</b> Steam Blaster™ Nozzle          |
| <b>D</b> Lower Cord Wrap               | <b>I</b> Steam Control Panel                 | <b>N</b> Intelli-Mop™ Head              |
| <b>E</b> Steam Cleaner Body            | <b>J</b> Filling Flask                       | <b>O</b> Dirt Grip™ Pad                 |

\*Flat head screwdriver required. Screwdriver not included.

**CAUTION:** Test in a small inconspicuous area and contact your surface manufacturer/installer for specific information on your surface.

## HANDHELD ACCESSORIES

### GARMENT STEAMER WITH BONNET AND BRISTLE FRAME

Ideal for removing wrinkles from clothing and for freshening and grooming upholstery.

Do not use this tool without the Microfiber Bonnet attached.



### ACCESSORY HOSE

For optimal range and mobility when cleaning above-floor surfaces.



### SMALL ABOVE-FLOOR POCKET TOOL AND PAD

Ideal for small, uneven surfaces, corners, and edges. Do not use without the pad attached.

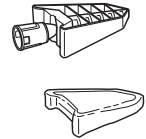

## ALSO INCLUDED FOR HANDHELD USE

- 1** Concentration Nozzle
- 2** Steam Blast Scrubbing
- 3** Copper Brush
- 4** Steam Crevice tool

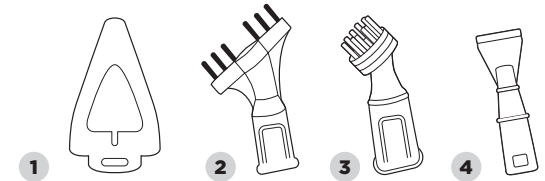

# ASSEMBLING YOUR STEAM CLEANER

★ **▲ WARNING:** Always make sure the Steam Cleaner is **UNPLUGGED** when not in use. Never fill the Steam Cleaner or attach the mop head when the Steam Cleaner is plugged into an electrical socket. To prolong the life of your Steam Cleaner, we recommend using distilled water. Make sure you add only water to the tank. Chemicals or cleaning solutions (including vinegar) may damage the Steam Cleaner and could be unsafe for you and your family.

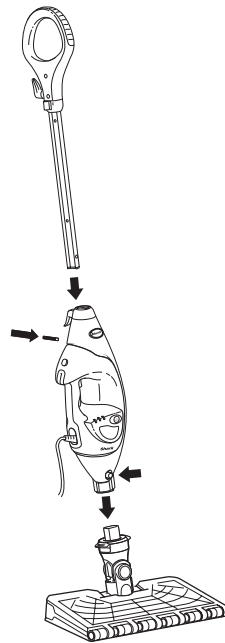

Fig. 1

**1** Screw the mop handle into the Steam Cleaner body (screwdriver not included) **(Fig. 1)**.

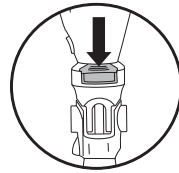

Fig. 2a

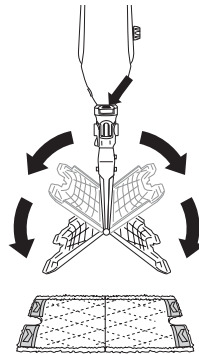

Fig. 2b

**2** Slide the Klik 'n' Flip® Head connector into the Steam Cleaner body. Push until you hear it click securely into place. **(Fig. 1)** To detach the Klik 'n' Flip® mop head, press the release button on the front of the unit above the head connection **(Fig. 1)** and slide off. **(Fig. 1)**

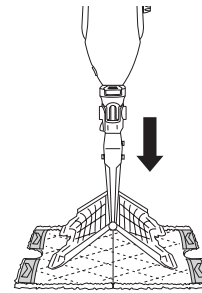

Fig. 3

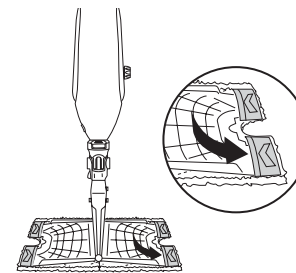

Fig. 4

**3** To attach the Dirt Grip™ pad, spread the pad on the floor with the pockets face up. Lift the mop and center the Klik 'n' Flip® Head above the pad, then press down on the release buttons on the neck of the Steam Cleaner head **(Fig. 2a)**. Both sides of the Klik 'n' Flip® Head will drop open **(Fig. 2b)**. Slip the Klik 'n' Flip® Head's four corner tabs into the four corner pockets of the pad **(Fig. 3 and Fig. 4)**. Gently press one side of the Klik 'n' Flip® Head to the floor until that side clicks into place **(Fig. 5)**. Repeat on the other side **(Fig. 6)**.

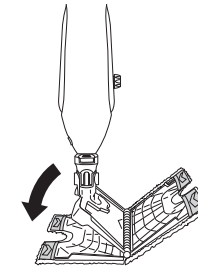

Fig. 5

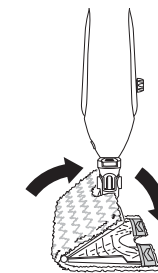

Fig. 6



Fig. 7

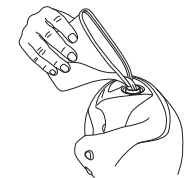

Fig. 8

**4** Open the water tank cap **(Fig. 7)**, fill the tank with water, then replace and tighten the cap. Use the filling flask and pour water into the tank **(Fig. 8)**. Do not overfill. Replace the cap on the water tank.

## USING YOUR STEAM CLEANER

★ **IMPORTANT:** Make sure you do not use the Steam Cleaner without attaching a Dirt Grip™ pad and adding water to the water tank first. When you are using the Steam Cleaner for the first time, it might take longer than the normal 30 seconds to start steaming.

★ **IMPORTANT:** Do not use on unsealed wood or unglazed ceramic floors. On surfaces that have been treated with wax and on some no-wax floors, the sheen may be removed by the heat and steam action. Test an isolated area of the surface to be cleaned before proceeding. Check the use and care instructions from the floor manufacturer.

**NOTE:** To prolong the life of your Steam Cleaner, we recommend using distilled water.

**NOTE:** Sweep or vacuum your floors prior to cleaning with your Steam Cleaner.

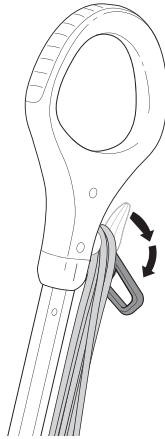

Fig. 9

- 1 Twist the upper cord holder to unwrap the power cord completely (**Fig. 9**). Plug into an electrical socket.
- 2 When it's first plugged in, the unit will be in Standby mode. The LO and HI lights below the Steam Control Button will blink to indicate Standby mode.
- 3 To select the steam mode, press the Steam Control Button once for LO, twice for HI and 3 times for Standby.
- 4 Clean your floors with a forward and backward motion.
- 5 When you need an extra burst of steam to clean a stuck-on stain, you can use the Steam Blaster™ feature. Flip the head over so that it is behind the mop body, then tilt the mop handle down. This will cause the the Steam Blaster™ (**Fig. 10**) to emit a concentrated blast of steam onto the stain.

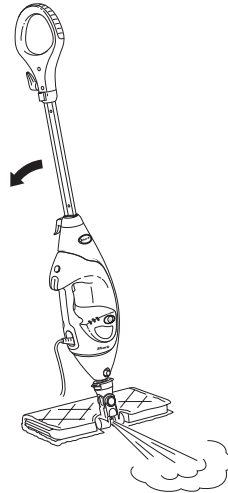

Fig. 10

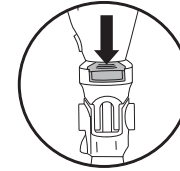

Fig. 11a

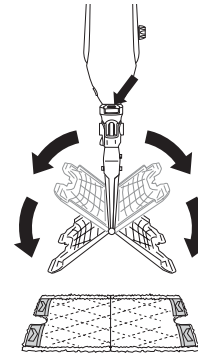

Fig. 11b

- ▲ **CAUTION: While in Steam Blaster™ mode, do not leave stationary for more than one minute.**
- ▲ **CAUTION: Do not scrub any one area for an extended period of time.**
- 6 To stop the Steam Blaster™ spray, simply raise the handle. You can then flip the mop head back into its original position and continue cleaning.
- 7 When you are done mopping, press the Steam Control Button until you return to Standby mode.
- 8 To remove the Dirt Grip™ pad, simply lift the mop straight up by the handle until the Intelli-Mop™ Head is hanging straight down. Press down on the pad release buttons on the neck of the mop head (**fig 11a**), and both sides of the head will drop open, releasing the pad (**fig 11b**).

9 Once the Dirt Grip™ pad has been released, close the Intelli-Mop™ Head. To close, gently press one side of the Intelli-Mop™ Head to the floor until that side clicks into place. Repeat on the other side.



10 When the water tank is empty, the Steam Cleaner will stop producing steam. You can refill the water tank at any time as long as the Steam Cleaner is unplugged. Follow the water tank filling instructions on page 7.

**NOTE:** Please wait 2 to 3 minutes for the Steam Cleaner to cool off before switching the mop head. Never leave the Steam Cleaner with a damp or wet Dirt Grip™ pad on any floor for an extended period of time.

## INTELLIGENT STEAM CONTROL

The **Shark® Steam Cleaner** has 3 unique Intelligent Steam Control settings so you can use the right amount of steam for the cleaning task at hand.

See below for tips on when to use each setting.

Setting	Ideal For These Sealed Surfaces	Recommended Usage
<b>TOOLS</b> 	Laminate Hardwood Marble	Cleaning delicate surfaces. Light cleaning and dusting. Loosening and lifting light dirt.
<b>LO</b> 	Hardwood Marble Tile Stone	Cleaning most surfaces and large areas. Basic, everyday cleaning. Removing spots and smaller messes. Cleaning moderate and heavy-traffic areas.
<b>HI</b> 	Hardwood Marble Tile Stone	Deep-cleaning and cleaning hard-to-clean surfaces. Tough cleaning and removing stuck-on messes and stains. Deep-cleaning heavy-traffic areas. Cutting through heavy dirt and grime. Sanitizing* floors.
<b>Steam Blaster™</b>	For an extra burst of steam, you can use the Steam Blaster™ feature in LO or HI. Follow the instructions found on the "Using your Steam Cleaner" page.	

### TO SANITIZE\* WITH THE STEAM CLEANER USING THE INTELLI-MOP™ HEAD AND THE DIRT GRIP™ PAD:

- 1 Attach a clean Dirt Grip™ pad to the mop head.
- 2 Plug in the unit and press the Steam Control Button to select the **HI** Setting.
- 3 Wait 30 seconds for the unit to begin producing steam.
- 4 Start mopping on an appropriate sealed hard floor surface with a forward and backward motion. After three minutes, your unit is ready to be used to sanitize.
- 5 Using a forward and backward motion, move the unit over the area you seek to sanitize. Repeat at least 5 times.

\* Sanitisation studies were conducted under controlled test conditions. Household conditions and results may vary. With Klik 'n' Flip® Mop in HI mode only when used with Steam Cleaner. Not in Steam Blaster™ mode.

## ABOVE-FLOOR CLEANING

For a full list of what is included with your Steam Cleaner, please refer to box's top panel.

The **Shark® Floor and Handheld Steam Cleaner** is designed to clean surfaces that can withstand high heat and moisture. Do not use on unsealed wood surfaces (especially antique wood furniture), unglazed ceramic tile, painted surfaces, or surfaces that have been treated with wax, oils, varnishes, or shellac. The sheen may be removed by the heat, steam, and friction of the cleaning accessories. It is always recommended to test an isolated area of the surface to be cleaned before proceeding.

We also recommend you check the use and care instructions from the surface manufacturer. When cleaning finished wood surfaces, use broad, continuous strokes. To prevent surface damage, avoid focusing steam or allowing the cleaning accessories to remain stationary in any one spot.

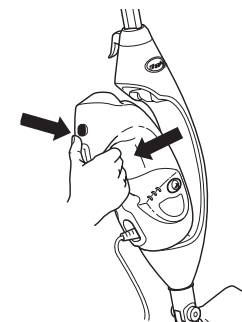

Fig. 12

- Remove the Handheld Steamer by pressing on the release button and pulling away from the cradle. Be careful to NOT press the steam trigger as you remove the handheld steamer. **(Fig. 12).**
- The Handheld Steamer is automatically set to TOOLS mode. Squeeze the steam trigger to activate steam. You may select other steam modes depending on the accessory and the use.
- With all attachments, control Steam better by using 3-to-5-second bursts of the trigger. This will allow you to steam longer and with more control.



## USING THE GARMENT STEAMER

### Certain models only

For a full list of what is included with your Steam Cleaner, please refer to box's top panel.

★ **CAUTION:** Make sure the Handheld Steamer is unplugged or in Standby mode while attaching or removing the accessory. Avoid touching the accessory, as it will be very hot after steaming.

★ **CAUTION:** To avoid scalding injuries, always unplug and allow the Steam Cleaner to cool before removing or changing accessories or pads.

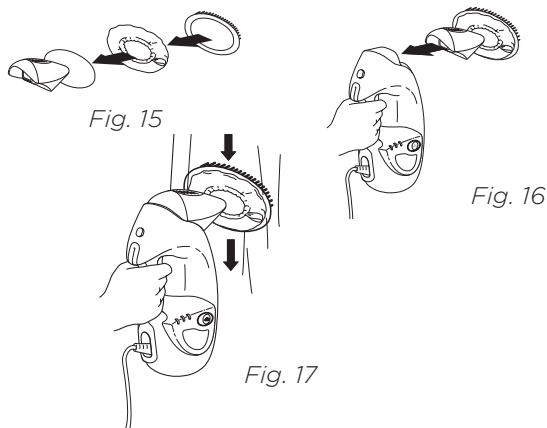

### How to Attach/Detach:

- Use the lavender loop on the side of the bonnet to slide over the nozzle opening of the Garment Steamer. **(Fig. 15).**
- Snap the bristle frame over the bonnet with the bristles placed at the top of the Garment Steamer bonnet.
- Attach the assembled Garment Steamer to the Handheld Steamer by snapping it into the main nozzle. **(Fig. 16).**
- To remove, wait 2 to 3 minutes for the tool to cool, hold the release button and pull the tool away from the unit.

### Usage:

- The Garment Steamer is ideal for removing wrinkles from clothing and for freshening and grooming upholstery.
- The bonnet and frame with bristles provide controlled steaming for fabrics and upholstery.

### Cleaning Tips:

- Pressing the steam trigger in 3-to-5-second bursts, move slowly up and down over your garments or upholstery. **(Fig. 17).**
- Always determine color fastness of any fabric, especially with reds or blues:
  - Take a clean, moist, warm towel and gently rub a small area on the fabric that is as out of sight and out of the way as possible.
  - If color bleeds onto the towel, you may need to have the piece professionally cleaned.

## USING THE ACCESSORY HOSE AND THE SMALL ABOVE-FLOOR POCKET TOOL

For a full list of what is included with your Steam Cleaner, please refer to box's top panel.

★ **CAUTION:** Make sure the Handheld Steamer is unplugged or in Standby mode while attaching or removing the accessory. Avoid touching the accessory, as it will be very hot after steaming.

★ **CAUTION:** To avoid scalding injuries, always unplug and allow the Steam Cleaner to cool before removing or changing accessories or pads.

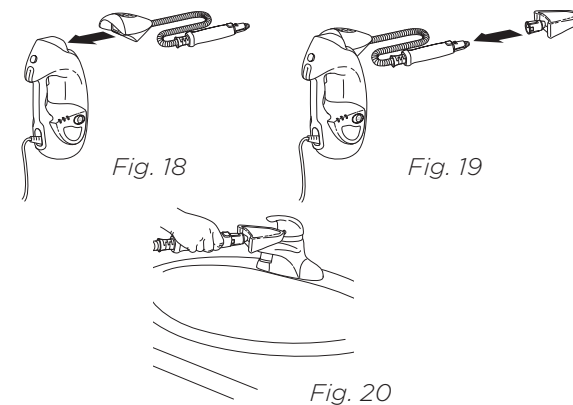

### How to Attach/Detach:

- First attach the Accessory Hose to the Handheld Steamer by snapping the Accessory Hose into the main nozzle. **(Fig. 18).**
- Slide the pad over the Small Above-Floor Pocket Tool so it fits snugly. Attach the elastic band and slide the locking toggle to securely tighten the pad over the tool.
- Connect the Small Above-Floor Pocket Tool to the steam nozzle at the end of the accessory hose. Slide the base of the tool over the tip of the nozzle until the tool clicks securely into place. **(Fig. 19).**
- Do not use the Small Above-Floor Pocket Tool without the pad attached.
- To remove, wait 2 to 3 minutes for the tool to cool, hold the release button and pull the tool away from the unit.

### Usage:

- The Small Above-Floor Pocket Tool is ideal for small, uneven surfaces. The pointed tip is great for edges and corners. **(Fig. 20).**

### Cleaning Tips:

- Additional attachments are available for your accessory hose. Please visit [sharkaccessories.com](http://sharkaccessories.com) for more information.



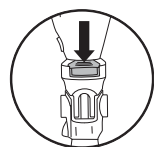

Fig. 21



Fig. 22

## After Use and Storage

- 1 Press the Steam Control Button until it starts to blink, indicating that you are in Standby mode. Unplug the cord from the socket and place the Steam Cleaner into the upright position. Let it cool.
- 2 To remove the Dirt Grip™ pad, lift the Steam Cleaner straight up by the handle until the Intelli-Mop™ Head is hanging straight down. Press the pad release buttons on the neck of the mop head, and both sides of the Intelli-Mop™ Head will drop open, releasing the pad. Once the pad has been released, close the Intelli-Mop™ Head.
- 3 If the Intelli-Mop™ Head is not attached to the mop, the pad can still be removed. Press down on the release button on the Intelli-Mop™ Head post to release the pad **(Fig. 21)**.
- 4 Empty the water tank before storing. To empty the tank, hold the Steam Cleaner beside a sink. Open the water tank lid, then lean the unit over the sink. Let the water drain out, then close the lid.
- 5 To store the Steam Cleaner, wait until after it has cooled and the steam has been released.

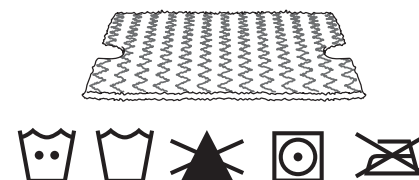

Fig. 23

## Dirt Grip™ Pad Care Instructions

Machine-wash the Dirt Grip™ pads separately with warm water using liquid detergent.

**NEVER USE BLEACH, POWDERED DETERGENT, OR FABRIC SOFTENERS** as they may damage or leave a coating on the Dirt Grip™ pads that will reduce their cleaning performance and absorbency. Dirt Grip™ pads should be line-dried or tumble-dried on a low setting, as this will extend the life of the microfiber fabric (Fig. 23).

Loose fibers can indicate wearing of the microfiber fabric. Do not pull the loose fibers, as this can cause the weave to come undone. Simply trim the loose fibers with scissors **(Fig. 24)**.

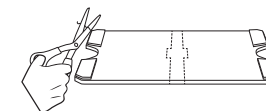

Fig. 24

## Replacement Dirt Grip™ pads



For best cleaning results, we recommend replacing your Dirt Grip™ pads every 3 to 4 months following normal use. As with any fabric, dirt particles, grease, friction, and repeated washing can cause the fibers to break down, and you may notice an increase in the effort needed to push or pull the mop.

You can purchase replacement Dirt Grip™ pads and other accessories by visiting [sharkclean.eu/parts](http://sharkclean.eu/parts) and accessories or calling 0800 862 0453.

## Steam Nozzle Care

If you believe the main steam nozzle or the Steam Blaster™ nozzle is clogged, please contact Customer Service at 0800 862 0453 or [sharkclean.eu](http://sharkclean.eu).

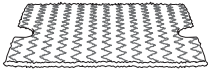
## ORDERING ADDITIONAL ACCESSORIES

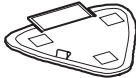
ACCESSORY	
<p><b>Intelli-Mop™ Head</b> Great for all-purpose cleaning. Get an extra boost for tough stains from the Steam Blaster™, and clean twice the area with the hands-free two-sided pad.</p>	
<p><b>Dirt Grip™ Pad</b> Double-sided pad. Easy, hands-free installation and removal. Washable and reusable.</p>	
<p><b>Triangle Scrubber Head</b> Triangle shape is perfect for cleaning corners and hard-to-reach areas. Equipped with a Steam Blaster™ to help loosen stains and stuck on dirt.</p>	
<p><b>Triangle Scrubber Pad</b> Ideal for cleaning corners and other hard-to-reach spaces. Easy to install and remove.</p>	

## TROUBLESHOOTING GUIDE

**⚠ WARNING: To reduce the risk of shock and unintended operation, turn off power and unplug unit before servicing.**

### The Steam Cleaner isn't producing any steam.

- The Steam Cleaner should be securely plugged into an electrical socket. Check your fuse or circuit breaker or try a different socket.
- Make sure the water tank is full, the unit is plugged in, and the light around the Steam Control Button is solid.
- If the lights below the Steam Control Button are not illuminated, try a different electrical socket.
- If the lights below the Steam Control Button are blinking, press the Steam Control Button to select a Steam setting.
- If the lights below the Steam Control Button are solid, wait 30 seconds for the unit to warm up.
- If after following the above steps the Steam Cleaner still does not produce any steam, contact Customer Service at 0800 862 0453 or sharkclean.eu

### The Steam Cleaner is producing intermittent steam.

- This is normal—for more consistent steam select the HI setting.
- Also make sure the water tank is full.

### I can't select a Steam Setting.

- Make sure the Steam Cleaner is plugged in and the lights below the Steam Control Button are solid.
- If your Steam Cleaner is producing steam but the lights below the Steam Control Button are not lit, call customer service at 0800 862 0453.

### I am getting streaky/cloudy floors.

- The Dirt Grip™ pad might be dirty. If it is, flip it over to the clean side or change it entirely. If you washed the Dirt Grip™ pad with powdered detergent, then it could be damaged and require replacement.
- This could also be an indication of soap or grease residue that has accumulated on the floor. As the Steam Cleaner uses only a small amount of water, it may not be enough to rinse off the accumulation of residue that the steam is bringing to the surface. We suggest rinsing the floor with nothing but water, letting it dry, and then steam clean again with a clean Dirt Grip™ pad. One or more rinses will generally remove the residue.
- A more stubborn case may require you to rinse the floor with a mix of one part vinegar and two parts water\* (but DO NOT put vinegar or any other cleaner into the Steam Cleaner's water tank.)
- \*Please consult your flooring manufacturer's care and maintenance instructions before applying any cleaning products or solutions including vinegar.

### What surfaces can I use the Steam Cleaner on?

- The Steam Cleaner is designed for use on all sealed hard floor surfaces. We recommend that you first test an isolated area of the floor surface to be cleaned as well as review the use and care instructions from your floor manufacturer.
- **CAUTION :** Do not use on leather, wax-polished furniture, synthetic fabrics, velvet, or other delicate, steam-sensitive materials.
- **NOTE:** On surfaces treated with wax and on some no-wax floors, the sheen may be removed by the heat or steam action of the unit. Test an isolated area of flooring first to see if sheen is affected.

### Can I put something other than water in the water tank of the Steam Cleaner?

- **DO NOT** add cleaning solutions, scented perfumes, oils, or any other chemicals to the water used in this appliance, as this may damage the unit or make it unsafe for use. We recommend using distilled water in your Steam Cleaner.

When a consumer buys a product in the UK, they get the benefit of legal rights relating to the quality of the product (your "statutory rights"). You can enforce these rights against your retailer. However, at Shark® we are so confident about the quality of our products that we give the original product owner an additional manufacturer's warranty of up to two years. (1 year as standard plus 1 year when you register) These terms and conditions relate to our manufacturer's warranty only - your statutory rights are unaffected. Please note that the 2 year guarantee is available in all EU countries and in the UK if it stops being an EU country during the guarantee term.

The conditions below describe the prerequisites and scope of our warranty. They do not affect your statutory rights or the obligations of your retailer and your contract with them.

#### Shark® Guarantees

A household appliance like a Steam Cleaner constitutes a sizeable investment. Your new machine needs to work properly for as long as possible. The guarantee it comes with is an important consideration - and reflects how much confidence the manufacturer has in its product and manufacturing quality.

Every Shark® machine comes with a free parts and labour guarantee. Our customer service helpline (0800 862 0453) is open from 9.00am to 6.00pm Monday - Friday. It's free to call, and you'll be put straight through to a Shark® representative. You'll also find online support at [www.sharkclean.eu/uk](http://www.sharkclean.eu/uk).

#### How do I register my extended Shark® guarantee?

You can register your guarantee online within 28 days of purchase. To save time, you'll need the following information about your machine:

- Date you purchased the machine (receipt or delivery note)
- To register online, please visit [www.sharkclean.eu/uk/register-guarantee](http://www.sharkclean.eu/uk/register-guarantee)

#### IMPORTANT

- Both the 12 months and the extended 1 year guarantee will only cover your product from the date of purchase.
- Please keep your receipt at all times. Should you need to use your extended guarantee we will need your receipt to verify the information you have supplied to us is correct. The inability to produce a valid receipt may invalidate your guarantee.

#### What are the benefits of registering my free Shark® guarantee?

When you register your guarantee we'll have your details to hand if we ever need to get in touch. If you further agree to receive communications from us, you can also receive tips and advice on how to get the best out of your Shark® Steam Cleaner and hear the latest news about new Shark® technology and launches. If you register your guarantee online, you'll get instant confirmation that we've received your details.

#### How long are new Shark® machines guaranteed for?

Our confidence in our design and quality control means that your new Shark® Steam Cleaner is guaranteed for a total of up to two years for the original owner (12 months plus an extended warranty of 1 year).

#### What is covered by the free Shark® guarantee?

Repair or replacement of your Shark® machine (at Shark's discretion), including all parts and labour. A Shark® guarantee is in addition to your legal rights as a consumer.

#### What is not covered by the free Shark® guarantee?

- Normal wear and tear
- Accidental damage, faults caused by negligent use or care, misuse, neglect, careless operation or handling of the Steam Cleaner which is not in accordance with the Shark® Operating Manual supplied with your machine.
- Use of the Steam Cleaner for anything other than normal domestic household purposes.
- Use of parts not assembled or installed in accordance with the operating instructions.
- Use of parts and accessories which are not Shark® Genuine Components.
- Faulty installation (except where installed by Shark®).
- Repairs or alterations carried out by parties other than Shark® or its agents.

#### What happens when my guarantee runs out?

Shark® does not design products to last for a limited time. We do appreciate that there may be a desire for our customers to want to repair their Steam Cleaner cleaners after the warranty has elapsed or the product has been sold to a new owner. In this case please contact our free phone customer service help line and ask about our out warranty program, on 0800 862 0453.

#### Where can I buy genuine Shark® spares and accessories?

Shark® spares and accessories are developed by the same engineers who developed your Shark® Steam Cleaner. You'll find a full range of Shark® spares, replacement parts and accessories for all Shark® machines at [www.sharkclean.eu](http://www.sharkclean.eu).

Please remember that using non-Shark® spares invalidates your guarantee.





**NOTE:** Save these instructions. Keep for future reference.



This marking indicates this product should not be disposed of with other household wastes throughout the EU. To prevent possible harm to the environment or human health from uncontrolled waste disposal, recycle it responsibly to promote the sustainable reuse of material sources. To return your used device, please use the return and collection systems or contact the retailer where this product was purchased. They can take this product for environmentally safe recycling.

**Euro-Pro Europe Limited**  
**3150 Century Way**  
**Thorpe Park**  
**Leeds**  
**LS15 8ZB**  
**0800 862 0453**  
**sharkclean.eu**

Illustrations may differ from actual product. We are constantly striving to improve our products, therefore the specifications contained herein are subject to change without notice.

©2019 SharkNinja Operating LLC. SHARK, KLIK 'N' FLIP, INTELLIGENT STEAM CONTROL and STEAM POCKET are registered trademarks of SharkNinja Operating LLC. LIFT-AWAY, INTELLI-MOP HEAD, STEAM BLASTER and DIRT GRIP are trademarks of SharkNinja Operating LLC.

S6005UK\_Series\_IB\_MP\_191213\_MV1  
PRINTED IN CHINA



IPX4

 **@sharkcleaninguk**

 **@sharkcleanuk**

 **@sharkcleanuk**