

Bestway®

#58386

220-240V~50Hz, 32W
IPX7 Hmin 0.19m



FLOWCLEAR™ FILTER PUMP OWNER'S MANUAL

www.bestwaycorp.com

Visit Bestway YouTube channel 



WARNING
IMPORTANT SAFETY INSTRUCTIONS

READ AND FOLLOW ALL INSTRUCTIONS

WARNING - RISK OF ELECTRIC SHOCK - The pump is to be supplied by an isolating transformer or supplied through a residual current device (RCD) having a rated residual operating current not exceeding 30 mA.

The appliance must be supplied by earthed power source.

Extension cords can't be used.

WARNING - RISK OF ELECTRIC SHOCK - The pump cannot be used while people are inside the pool.

DO NOT BURY CORD. Locate cord to minimize abuse from lawn mowers, hedge trimmers, and other equipment.

WARNING - The supply cord cannot be replaced. If the cord is damaged the appliance should be scrapped.

CAUTION - This pump is for use with storable pools only. Do not use with permanently-installed pools. A storable pool is constructed so that it is capable of being readily disassembled for storage and reassembled to its original integrity. A permanently-installed pool is constructed in or on the ground or in a building such that it cannot be readily disassembled for storage.

IMPORTANT - Using the pump with an unmatched electrical supply is dangerous and will result in catastrophic failure of pump.

RISK OF ELECTRICAL SHOCK- When working with electricity, turn the electrical power off at the circuit breaker and lock breaker door. Failure to do so will result in increased risk of shock, injury and possibly death.

DO NOT REMOVE THE GROUNDING PRONG OR MODIFY THE PLUG IN ANY WAY. DO NOT USE ADAPTOR PLUGS. Consult a qualified electrician for any questions related to the validity of your plugs grounding.

Handle the pump with care. Do not pull or carry the pump by the power cord. Never pull a plug from the outlet by yanking the power cord. Keep cord free from abrasions. Sharp objects, oil, moving parts, and heat should never be exposed to the filter pump.

WARNING - This appliance is not intended for use by persons (including children) with reduced physical, sensory or mental capabilities, or lack of experience and knowledge, unless they have been given supervision or instruction concerning use of the appliance by a person responsible for their safety. Children should be supervised to ensure that they do not play with this product.

CAUTION: Read the instruction before using the appliance and installation/reassemble each time.

Cleaning and user maintenance must be performed by an adult above 18 years old who is familiar with the risk of electric shock.

NOTE:

Please examine equipment before use. Notify Bestway at the customer service address listed on this manual for any manufacturing defect or missing parts at the time of purchase. Verify that the equipment components represent the filter pump model that you had intended to purchase.

NOTE:

Place pump on a solid and level ground. Pay attention to position of pool and pump so adequate ventilation, drainage, and access for cleaning is available. Never place pump in an area that may accumulate water, or in an area where foot traffic will flow around the pool.

It is necessary to have the plug accessible after installation of the pool.

NOTE:

Atmospheric conditions may affect the performance and life span of your filter pump. Unnecessary wear and tear may occur during periods of cold, heat and exposure to sun. Whenever possible shelter pump from these conditions.

It is important to ensure the factory equipped stopper plugs for the inlet and outlet ports replace the screens before removal or maintenance on the pump is attempted.

NOTE:

Do not add chemicals in the filter pump.

Don't plug or unplug the appliance if hand is wet

Always unplug the appliance:

- On raining days
- Before cleaning or other maintenance
- Leave it unattended on holidays

When the appliance will be not used for long time, such as in the winter, the pool set should be disassembled and stored indoor.

Safekeeping the instruction. For reconstruction the pool set every time, please always refer to the instructions.

-If instruction is missed, please contact with Bestway or search it in website: www.bestwaycorp.com

NOTE: This product is not intended for commercial use.

SAVE THESE INSTRUCTIONS.

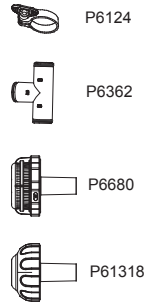
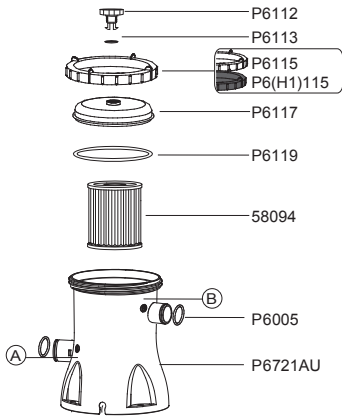

	A	B	C
P6112	1	1	1
P6113	1	1	1
P6115/P6(H1)115	1	1	1
P6117	1	1	1
P6119	1	1	1
58094	1	1	1
P6721AU	1	1	1
P6019	2	2	2
P6132	2	2	0
P6124	8	5	2
P6005	5	5	2
P6362	1	1	0
P6680	2	0	0
P61318	1	0	0

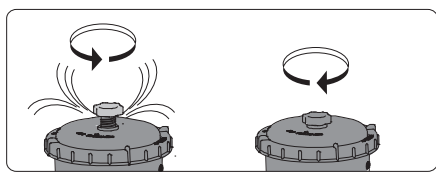
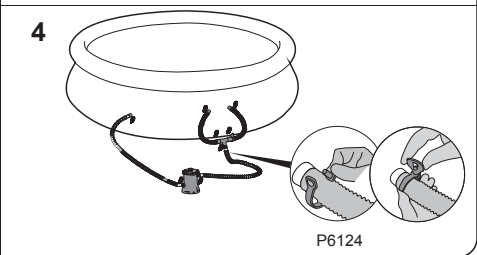
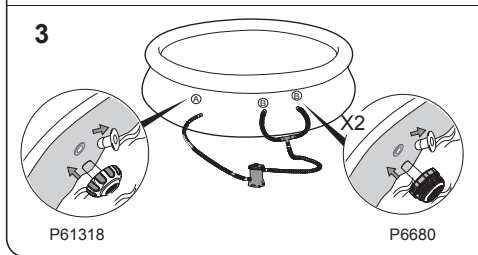
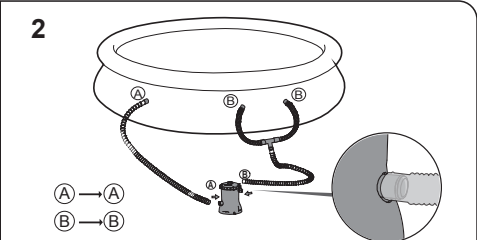
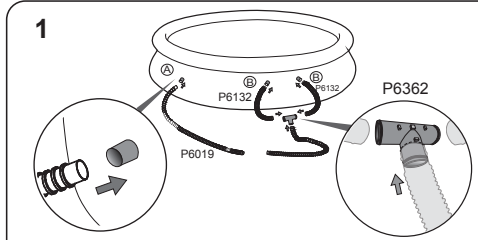
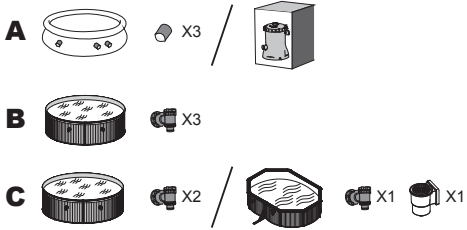

PEDESTAL FIXING

IEC60335-2-41 TEST standard requires the filter pump to be vertically fixed on ground or a certain pedestal made of wood or concrete before use. There should be two holes 9mm in diameter on the pedestal, the space between which should be 166mm. Put filter pump on the pedestal and fix them together by fasten the bolts and nuts. All the pedestal parts should weigh over 18kgs at least to prevent the pump from accidentally falling.

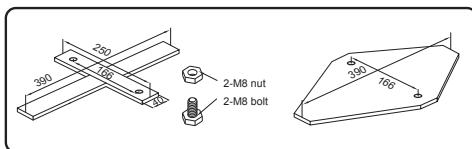

NOTE: It is imperative to check that the hydraulic connectors are not closed.

Operation

- 1) Open/unscrew the Air Purge Valve (P6112) on the top of the Filter Pump; air is released as water fills the Filter Pump.
- 2) When water comes out of the Air Purge Valve (P6112) screw it closed and wipe away any water.
- 3) To start the Filter Pump, insert the plug into a residual current device (RCD).

IMPORTANT: DO NOT DRY RUN THE FILTER PUMP - Make sure both the pool's Inlet and Outlet valves are fully covered by water before operating the Filter Pump.

Maintenance

CAUTION: YOU MUST ENSURE THE FILTER PUMP IS UNPLUGGED BEFORE ANY MAINTENANCE OR STORAGE BEGINS OR SEVERE RISK OF INJURY OR DEATH EXISTS.

- 1) Unplug the Filter Pump.
- 2) Loosen the Hose Clamps on the pool's Inlet and Outlet Hoses by unscrewing the fly nut counter-clockwise.
- 3) Remove Debris Screens from the inside of the pool.
- 4) Replace the Debris Screens with the Stopper Plugs in the pool's Inlet and Outlet Valves.
- 5) Unscrew the Filter Cap Retainer and remove the Filter Cap.
- 6) Clean the Filter Cartridge with a garden hose, if filter cartridge remains soiled or discolored, it is necessary to replace it with a new one.
- 7) Insert the cleaned (or new) Filter Cartridge; ensure it is centered in the Filter Pump.
- 8) Check that the Filter Cap Seal is in place.
- 9) Replace the Filter Cap and screw the Filter Cap Retainer into position.
- 10) Replace the Stopper Plugs with the Debris Screens in the pool's Inlet and Outlet Valves. Tighten the Hose Clamps. Water will now flow to the pump.
- 11) Follow the PUMP INSTALLATION DIRECTIONS section to prepare the system for use.

IMPORTANT: For sanitary reasons we suggest replacing the Filter Cartridge with a new one every two weeks.

STORAGE

- 1) Unplug the Filter Pump.
- 2) Follow the instructions as previously outlined to stop water flowing to the Filter Pump and to remove the Filter Cartridge.
- 3) Discard the Filter Cartridge.
- 4) Detach all Hoses.
- 5) Dry all components thoroughly.
- 6) Store the filter pump in a dry location out of the reach of children. Storage temperature: 4-40°C (39.2-104°F)

Pump Warranty

For information concerning pump warranty please visit our website at: www.bestwaycorp.com

Limited BESTWAY® Manufacturer's Warranty

The product you have purchased comes with a limited warranty. Bestway® stands behind our quality guarantee and assures, through a replacement warranty, your product will be free from manufacturer's defects.

To enact a warranty claim, this form must be completed and submitted with a copy of your purchase receipt to your local Bestway After Sales Center. Please contact your local Bestway After Sales Center before sending any documents. They will provide full instructions of what is needed for your claim. Bestway® will not replace any products deemed to be damaged due to negligence or having been used outside of the owner's manual guidelines.

Bestway's warranty covers manufacturing defects discovered while unpacking the product or during use as recommended within the user manual. This warranty applies only to products which have not been modified by any 3rd parties. The product must be stored and handled in accordance with the technical recommendations.

The warranty does not cover damages caused by misuse, abuse, neglect, including, but not limited to collision, fire, use of incorrect voltage, excessive heat exposure, improper installation, improper wiring or testing, or improper storage.

Replacements and repairs don't extend the duration of the warranty. The warranty start date is the date of sale shown on the original receipt/purchase invoice.

Please copy the Batch Number found on the body of the filter pump.

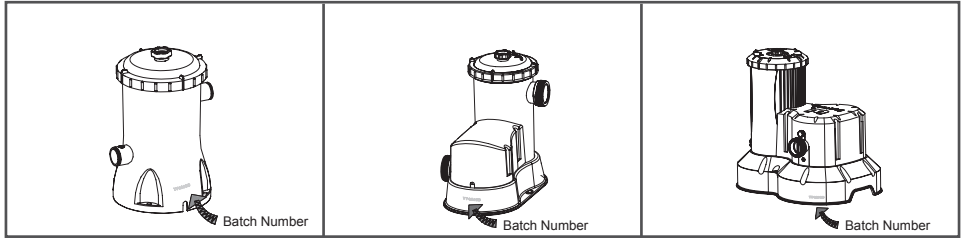

Batch Number: _____ Date of purchase: _____
 TO: Bestway® Service Department Date: _____
 Customer Code Number: _____

FAX/E-MAIL/TEL: Please refer to your country according to the information found on the back cover or on our website: www.bestwaycorp.com
 Please provide your address details in full. **Note:** Incomplete address details will result in delayed shipments.
 Bestway reserves the right to charge for redelivery of undelivered packages where the recipient is at fault.

REQUIRED INFORMATION - PLEASE WRITE THE DELIVERY ADDRESS

Name: _____ Address: _____
 Zip Code: _____ Retailer: _____
 Country: _____ City: _____
 Mobile: _____ Telephone: _____
 Fax: _____ E-mail: _____

Please Clearly Write Your Item Code: _____

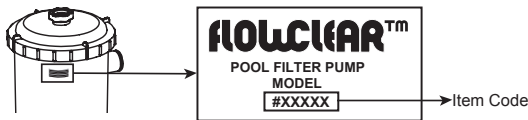

All drawings for illustration purpose only. Not to scale.

Problem description

- Water leakage Stopped working
 Missing part - Please use the code for the missing part. This can be found in the owner's manual.

Other (Please describe) _____

IMPORTANT: ONLY THE DAMAGED PART WILL BE REPLACED, NOT THE COMPLETE SET.

Bestway reserves the right to request photographic evidence of defective parts, or to require sending the item for additional testing.
 In order to best assist you, we request all information you provide to be complete.

FOR FAQ, MANUALS, VIDEOS OR SPARE PARTS, PLEASE VISIT OUR WEBSITE: www.bestwaycorp.com
 VIDEOS ARE ALSO AVAILABLE ON OUR BESTWAY CHANNEL ON YOU TUBE:
www.youtube.com/user/BestwayService

