

User's Guide

EH-TW7100

EH-TW7000

Home Projector

Using Each Guide

The guides for this projector are organized as shown below.

Safety Instructions/Support and Service Guide

Contains information on using the projector safely, as well as a support and service guide, troubleshooting check lists, and so on. Make sure you read this guide before using the projector.



User's Guide (this guide)

Contains information on setting up and basic operations before using the projector, using the Configuration menu, and handling problems and performing routine maintenance.



Quick Start Guide

Contains information on the procedures for setting up the projector. Read this first.

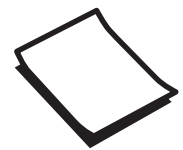



Notations Used in This Guide

Safety Indications

The documentation and the projector use graphical symbols to show how to use the projector safely. The following shows the symbols and their meanings. Please understand and respect these caution symbols in order to avoid injury to persons or property.

 **Warning**

This symbol indicates information that, if ignored, could possibly result in personal injury or even death due to incorrect handling.



 **Caution**

This symbol indicates information that, if ignored, could possibly result in personal injury or physical damage due to incorrect handling.

General Information Indications

Attention

Indicates procedures which may result in damage or malfunctions to occur.

	Indicates additional information and points which may be useful to know regarding a topic.
	Indicates a page where detailed information regarding a topic can be found.
Menu Name	Indicates Configuration menu items. Example: Image - Color Mode
[Hardware Names]	Indicates the buttons on the remote control or the control panel. Example: [Menu] button

About the Use of "This Product" or "This Projector"

As well as the main projector unit, supplied items or optional extras may be referred to using the phrase "this product" or "this projector".

Organization of the Guide and Notations in the Guide

Using Each Guide	1
Notations Used in This Guide	2
Safety Indications	2
General Information Indications	2
About the Use of "This Product" or "This Projector"	2

Introduction

Projector Features	6
Project Images from Mobile Devices	6
Other Useful Functions	6
Part Names and Functions	7
Front/Top	7
Control Panel	8
Remote Control	10
Rear	12
Base	13

Preparing

Installing	14
Projected Image and Position of Projector	14
Installing in parallel with the screen	14
Installing the projector horizontally by adjusting the height of either side	14
Various Setting Methods	15
Placing on a table and projecting	16
Suspending from the ceiling and projecting ..	16
Projection Distance and Lens Shift Maximum Values	17
Connecting a Device	20
Connecting Video Equipment	20
Connecting a Computer	20
Connecting External Equipment	20
Connecting to the Trigger Out port (EH-TW7100 only)	20
Connecting Bluetooth® devices	21
Connecting external speakers	23
Attaching the Wireless LAN Unit	23
Preparing the Remote Control	24

Installing the Remote Control Batteries	24
Remote Control Operating Range	24
Operating range (left to right)	24
Operating range (top to bottom)	24

Basic Operations

Projecting Images	25
Turning On the Projector	25
If the target image is not projected	26
Using the Home Screen	26
Turning Off	27
Adjusting the Projected Image	28
Displaying the Test Pattern	28
Adjusting the Focus	28
Adjusting the Projection Size (Adjust Zoom) . . .	29
Adjusting the Projector's Tilt	29
Adjusting the Position of the Image (Lens Shift) .	29
Correcting Keystone Distortion	30
Correct using the Keystone button	31
Correcting with Quick Corner	32
Adjusting the Volume	33
Hiding the Image and Muting the Audio Temporarily (A/V Mute)	33

Adjusting the Image

Adjusting the Image	34
Selecting the Projection Quality (Color Mode) . .	34
Switching the Screen Between Full and Zoom (Aspect)	34
Adjusting the Sharpness	36
Adjusting Image Resolution (Image Enhancement)	37
Setting Auto Iris	38
Setting Frame Interpolation	38
Setting the Image Processing Speed	39
Adjusting the Color	40
Adjusting the Color Temp.	40
Adjusting the RGB (Offset and Gain)	40
Adjusting Hue, Saturation, and Brightness	41
Adjusting the Gamma	42
Select and adjust the correction value	42

Adjust using the gamma adjustment graph . . .	42
Viewing the Image at the Saved Image Quality (Memory Function)	44
Saving a Memory	44
Loading, Deleting, and Renaming a Memory	44
Useful Functions	
Enjoying 3D Images	46
Preparing to View 3D Images	46
If the 3D image cannot be viewed	46
Using 3D Glasses	47
Warnings Regarding Viewing 3D Images	47
Using the HDMI Link Function	49
HDMI Link Function	49
HDMI Link Settings	49
Connecting	50
Using the Projector on a Network	
Projecting Using Wireless LAN	51
Selecting Wireless Network Settings Manually . .	51
Selecting the Computer's Wireless LAN Settings .	53
Selecting wireless network settings in Windows	53
Selecting wireless network settings in OS X . .	53
Setting Up Wireless Network Security	54
Projecting in Epson iProjection (iOS/Android) . . .	54
Operating using a smartphone (remote control function)	56
Configuration Menu	
Configuration Menu Functions	58
Configuration Menu Operations	58
Configuration Menu Table	59
Image menu	59
Signal menu	61
Settings menu	62
Extended menu	65
Network menu	67
Info menu	70
Reset menu	70

Troubleshooting

Problem Solving	71
Reading the Indicators	71
Indicator status during an error/warning	71
Indicator status during normal operation	73
When the Indicators Provide No Help	74
Check the problem	74
Problems relating to images	75
Noise problems	78
Problems when projection starts	78
Problems with the remote control	79
Problems with the control panel	79
Problems with 3D	79
Problems with HDMI	80
Bluetooth device problems	81
Network problems	81
About Event ID	82

Maintenance

Maintenance	84
Cleaning the Parts	84
Cleaning the air filter	84
Cleaning the main unit	85
Cleaning the lens	86
Replacement Periods for Consumables	86
Air filter replacement period	86
Lamp replacement period	86
Replacing Consumables	86
Replacing the air filter	86
Replacing the lamp	87
Resetting lamp hours	89

Panel Alignment 90

Color Uniformity 92

Appendix

Optional Accessories and Consumables	94
Optional Items	94
Consumables	94

Supported Resolutions	95
PC	95
SD	95
HD	95
4K	96
3D	97
Specifications	99
EH-TW7100/EH-TW7000	99
Appearance	102
List of Safety Symbols	103
Glossary	105
General Notes	106
Warning Labels	106
General Notice	107

Projector Features

Project Images from Mobile Devices

By using Epson iProjection, you can wirelessly connect the projector to smartphones and tablets. You can download Epson iProjection for free from the App Store or from Google Play.

 [p.54](#)



Other Useful Functions

In addition, the following useful functions are provided.

- Playing audio through the internal speaker. This allows you to enjoy audio without an external speaker. (EH-TW7100 only)
- Operate by remote control from a smartphone. By using Epson iProjection, you can operate the projector from a smartphone or tablet.  [p.56](#)



Part Names and Functions

Front/Top

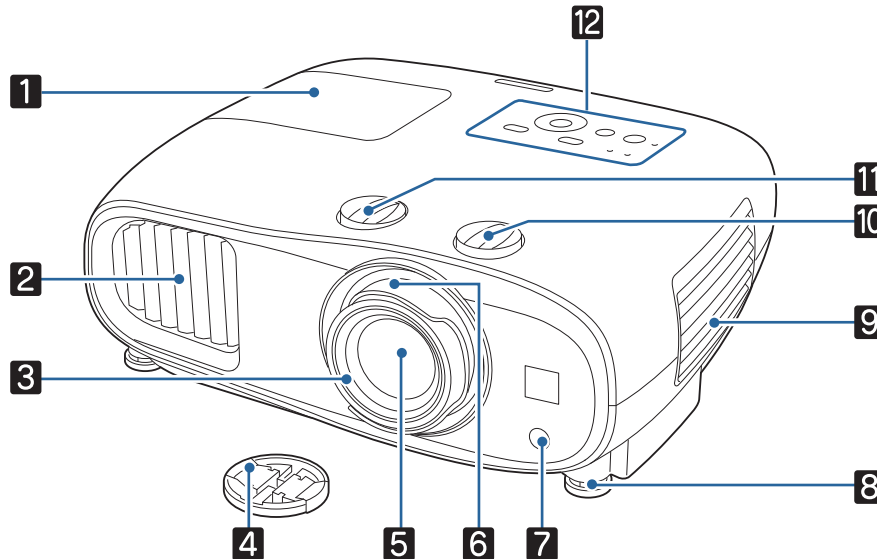

Name		Function
1	Lamp cover	Open when replacing the projector's lamp. p.87
2	Air exhaust vent	Exhaust vent for air used to cool the projector internally. <div style="border: 1px solid black; padding: 5px;"> <p> Caution</p> <p>While projecting, do not put your face or hands near the air exhaust vent, and do not place objects that may become warped or damaged by heat near the vent. Hot air from the air exhaust vent could cause burns, warping, or accidents to occur.</p> </div>
3	Focus ring	Adjusts the image focus. p.28
4	Lens cap	Install when not using the projector to protect the lens from being scratched or soiled. p.25
5	Lens	Images are projected from here.
6	Zoom ring	Adjusts the image size. p.29
7	Remote receiver	Receives signals from the remote control. p.24
8	Front adjustable foot	When set up on a surface such as a table, extend the foot to adjust horizontal tilt. p.29
9	Air filter cover	When cleaning or replacing the air filter, open this cover and remove the air filter. p.84 , p.86
	Air intake vent	Intake vent for air used to cool the projector internally.
10	Vertical lens shift dial	Turn the dial to move the position of the projected image up or down. p.29
11	Horizontal lens shift dial	Turn the dial to move the position of the projected image left or right. p.29







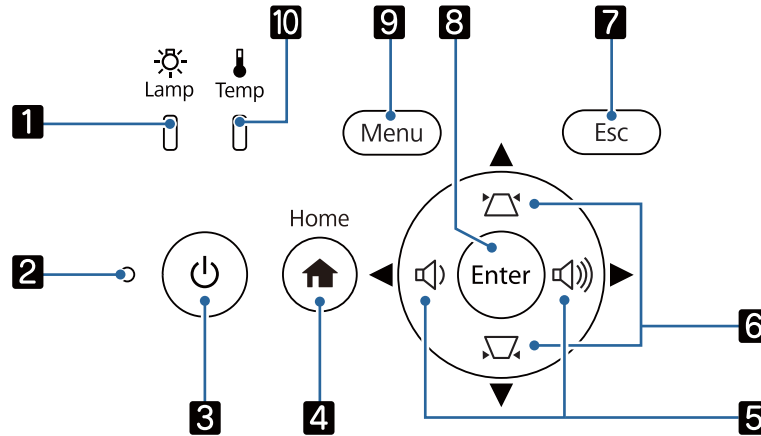



Name	Function
12 Control panel	Operates the projector. p.8

Control Panel

The control panel varies depending on the projector model you are using. The examples in this section are for the control panel for the EH-TW7100.



Buttons (Indicators)	Function
1 (Lamp indicator)	Flashes orange when it is time to replace the lamp. Shows the projector's errors through a combination of other indicators lit and flashing. p.71
2 (Status indicator)	Flashes to indicate the projector is warming up or cooling down. Shows the projector's status through a combination of other indicators lit and flashing. p.71
3 Standby (Standby indicator)	Turns the projector on or off. p.25 Lit when the projector is on. Shows the projector's status through a combination of other indicators lit and flashing. p.71
4 [Home]	Displays or closes the Home screen. p.26
5 EH-TW7100: Volume (Left/Right) EH-TW7000: Left/Right	<ul style="list-style-type: none"> Adjusts the volume. (EH-TW7100 only) p.33 Selects menu items or adjustment values while displaying the projector's menu. p.58 When the Keystone screen is displayed, you can adjust horizontal distortion in the projected image. p.30

	Buttons (Indicators)	Function
6	 Top/Bottom	<ul style="list-style-type: none"> • Selects menu items or adjustment values while displaying the projector's menu.  p.58 • Adjusts keystone distortion in projected images.  p.30
7	 [Esc]	Returns to the previous menu level when a menu is displayed.  p.58
8	 [Enter]	When a menu is displayed, it confirms the current item and moves to the next level.  p.58
9	 [Menu]	Displays and closes the Configuration menu. On the Configuration menu, you can make adjustments and settings for Signal, Image, and so on.  p.58
10	 (Temperature indicator)	Flashes orange if the internal temperature is too high. Shows the projector's errors through a combination of other indicators lit and flashing.  p.71



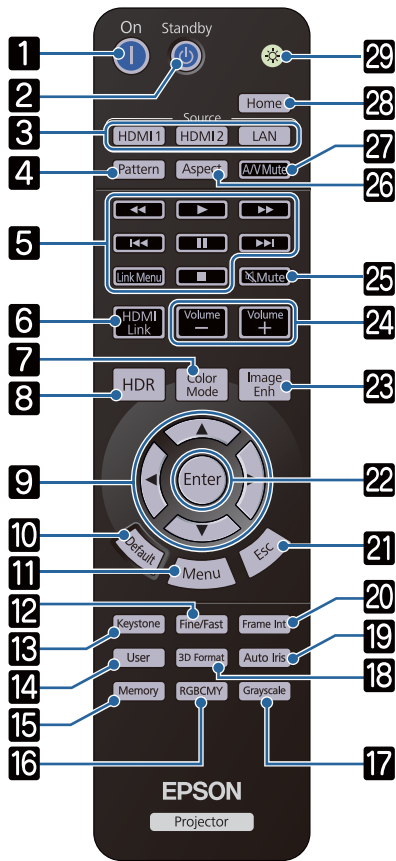

When the Illumination function is set to **Off**, all indicators are off under normal projection conditions.  **Extended - Operation - Illumination** [p.65](#)

Remote Control

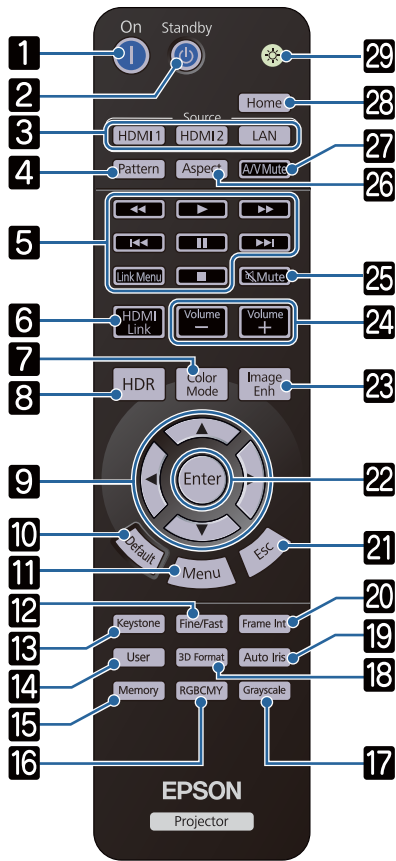

Button	Function
1 Power supply (On)	Turns the projector on. p.25
2 Standby (Standby)	Turns the projector off. p.27
3 [HDMI1] [HDMI2] [LAN]	Changes to the image from each input port. p.26
4 [Pattern]	Displays or closes the test pattern. p.28
5 Playback controls [Link Menu]	Performs operations such as play and stop for connected devices that meet the HDMI CEC standards. p.49
6 [HDMI Link]	<ul style="list-style-type: none"> When HDMI Link is On Displays the device connections list. When HDMI Link is Off Displays the HDMI link settings menu. p.49
7 [Color Mode]	Selects the Color Mode . p.34
8 [HDR]	Displays the adjustment screen for Dynamic Range . p.61
9 Top/Bottom/Left/Right	Selects menu items and adjustment values. p.58
10 [Default]	The adjustment value returns to its default value when pressed while the menu's adjustment screen is displayed. p.58
11 [Menu]	Displays and closes the Configuration menu. On the Configuration menu, you can make adjustments and settings for Signal, Image, and so on. p.58
12 [Fine/Fast]	Smoothly projects images with a quick frame rate, such as games. p.39
13 [Keystone]	Corrects distortion in the image. p.30
14 [User]	Performs the function assigned to the User button. p.62
15 [Memory]	Saves, loads, or erases a memory. p.44
16 [RGBCMY]	Adjusts the hue, saturation, and brightness for each RGBCMY color. p.41
17 [Grayscale]	Sets the Grayscale adjustment level. p.59



Button	Function
18 [3D Format]	Changes the 3D format. This projector supports the following 3D formats. <ul style="list-style-type: none"> • Frame Packing • Side by Side • Top and Bottom 👉 p.46
19 [Auto Iris]	Sets Auto Iris . 👉 p.38
20 [Frame Int]	Sets the strength for Frame Interpolation . 👉 p.38
21 [Esc]	Returns to the previous menu level when a menu is displayed. 👉 p.58
22 [Enter]	When a menu is displayed, it confirms the current item and moves to the next level. 👉 p.58
23 [Image Enh]	Displays the Image Enhancement menu. 👉 p.37
24 [Volume]	Adjusts the volume. 👉 p.33
25 [Mute]	Temporarily mutes or plays the audio. 👉 p.33
26 [Aspect]	Selects the aspect mode according to the input signal. 👉 p.34
27 [A/V Mute]	Temporarily hides or shows the image and audio. 👉 p.33
28 [Home]	Displays or closes the Home screen. 👉 p.26
29 	When you press this button, the remote control buttons light up for approximately 10 seconds. This is useful when operating the remote control in the dark.

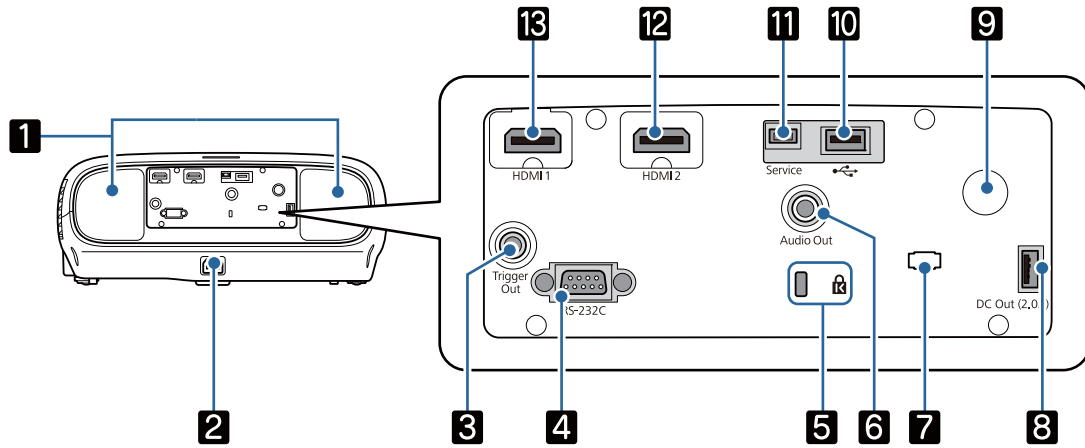

Rear

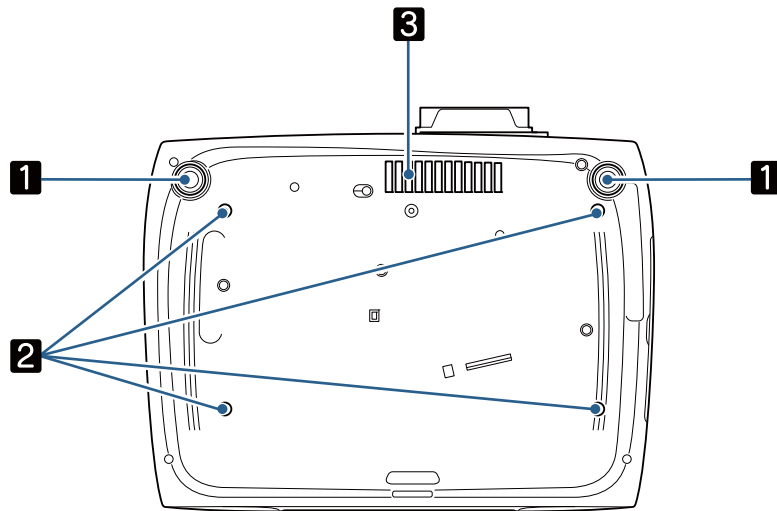

Name		Function
1	Speaker (EH-TW7100 only)	The projector's built-in speaker. Outputs audio. Set Inverse Audio to On to use the built-in speaker when the projector is suspended from a ceiling. ☛ Settings - Audio - Inverse Audio p.62
2	Power inlet	Connect the power cord. ☛ p.25
3	Trigger Out port (EH-TW7100 only)	Connects with external devices such as motorized screens. ☛ p.20
4	RS-232C port (EH-TW7100 only)	When controlling the projector, connect the projector to a computer with an RS-232C cable. This port is for control use and should not normally be used. ☛ p.99
5	Security slot (🔒)	The security slot compatible with the MicroSaver security system manufactured by Kensington. For more details, visit the homepage of Kensington at http://www.kensington.com/ .
6	Audio Out port	Outputs audio during playback to external speakers. ☛ p.23
7	Cable holder	The weight of the cable may result in imperfect insertion of its connector. Put a commercially available clamping band (cable tie) through this holder to bind and fix the cable to prevent them from becoming loose.
8	DC Out (2.0A) power supply port	Provides power to media streaming devices.
9	Remote receiver	Receives signals from the remote control. ☛ p.24
10	USB port	Connects the optional Wireless LAN unit. It is also used when updating the firmware. ☛ p.23
11	Service port	Service port. This is not normally used.
12	HDMI2 port	Connects HDMI compatible video equipment and computers. ☛ p.20
13	HDMI1 port	

Base



Name		Function
1	Front adjustable foot	When set up on a surface such as a table, extend the foot to adjust horizontal tilt.  p.29
2	Ceiling mount fixing points (four points)	Attaches the optional ceiling mount here when suspending the projector from a ceiling.  p.94
3	Air intake vent	When suspending from a ceiling, make sure it is setup so that dust does not collect in this section.

Installing

Projected Image and Position of Projector

Install the projector as follows.

■ Installing in parallel with the screen

If the projector is installed at an angle to the screen, keystone distortion occurs in the projected image. Adjust the projector's position so that it is installed in parallel with the screen.

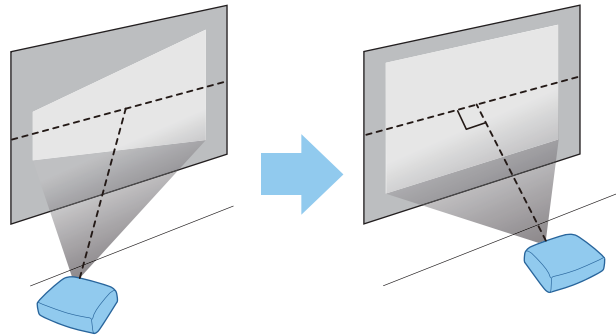

If the projector cannot be installed in front of the screen, you can adjust the position of the image by using lens shift. [p.29](#)

■ Installing the projector horizontally by adjusting the height of either side

If the projector is tilted, the projected image is also tilted.

Install the projector horizontally so that both sides are at the same height.

If the projector cannot be installed horizontally, you can adjust the projector's tilt with the front foot. [p.29](#)

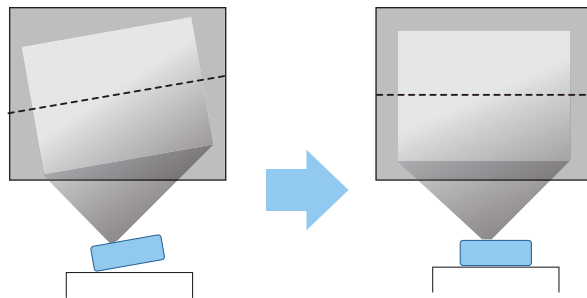

Various Setting Methods

Warning

- A special method of installation is required when suspending the projector from a ceiling (ceiling mount). If it is not installed correctly, it could fall, causing an accident and injury.
- Failure to install the ceiling mount and projector may cause the projector to fall. After installing the specific Epson mount that supports this projector, make sure you secure the projector and the mount using wire that is strong enough to hold their weight.
- Do not apply oils, lubricants, detergents, solvents, chemicals, and so on to the projector case or the mount. Otherwise, the projector case may deteriorate or be damaged causing the projector to fall from the mount.
- Do not set up the projector in locations exposed to humidity or dust, or in locations exposed to oil smoke or steam such as on a kitchen counter, in the kitchen, or near a humidifier. Doing so could cause fire or electric shock. In addition, the oil content could cause the projector's outer case to deteriorate and could cause the projector to fall off from the ceiling where it is suspended.

Examples of environments that could cause the projector to fall due to case deterioration/damage

- Locations subject to oily smoke, such as factories, restaurant kitchens, or home kitchens
- Locations containing volatile solvents or chemicals, such as factories or laboratories
- Locations where oil, detergents, chemicals, and so on could adhere to the projector such as factories, restaurant kitchens, or home kitchens
- Locations in which aroma oils are often used, such as relaxation rooms
- Locations near devices that produce excessive smoke, airborne oil particles, or foam at events
- Do not install in locations where salt damage could occur, or in locations subject to corrosive gas such as sulphuric gas from hot springs. Otherwise, corrosion could cause the projector to fall. It could also cause the projector to malfunction.
- Do not install it on an unstable shelf or in a place out of load range. Otherwise, it could fall or topple causing an accident and injury.
- When installing the projector in a high position such as on a shelf, take measures against falling by using wires or belts to ensure safety in an emergency such as an earthquake, and to prevent accidents. If it is not installed correctly, it could fall causing an accident and injury.
- Do not block the air intake vent and air exhaust vent of the projector. Blocking its air intake vent and air exhaust vent may trap heat inside causing fire.

Attention

- Do not use the projector installed vertically. Doing so could cause a malfunction.
- Clean the air filter once every three months. Clean it more often if the environment is particularly dusty.

 [p.84](#)

■ Placing on a table and projecting

You can install the projector on a table in your living room or on a low shelf to project images.

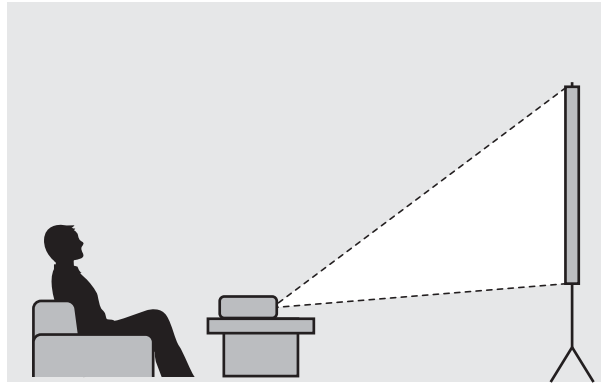

■ Suspending from the ceiling and projecting

You can suspend the projector from the ceiling with the optional ceiling mount to project images.

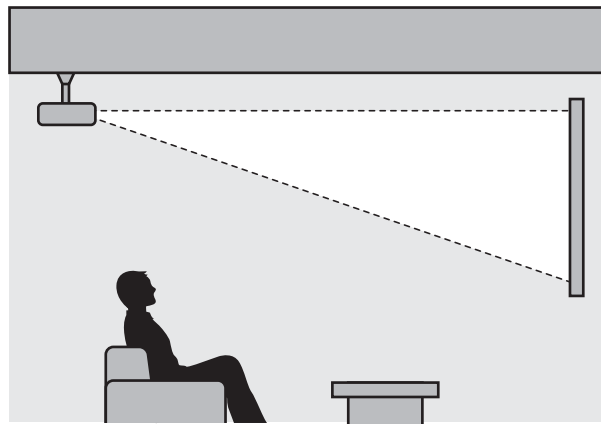

- When suspending from the ceiling and projecting, set **Projection** to **Front/Ceiling** or **Rear/Ceiling**.
☛ **Extended - Projection** [p.65](#)
- Set **Inverse Audio** to **On** to use the built-in speaker when the projector is suspended from a ceiling.
(EH-TW7100 only) ☛ **Settings - Audio - Inverse Audio** [p.62](#)

Projection Distance and Lens Shift Maximum Values

The size of the projection increases as the projector is moved away from the screen.

Use the table below to setup the projector at the optimum position from the screen. The values given here are for your reference only.

The maximum lens shift adjustment values are shown in the following table.



The projected image becomes smaller after correcting distortion. Increase the projection distance to fit the projected image to the screen size.

When adjusting the projection position vertically in lens shift

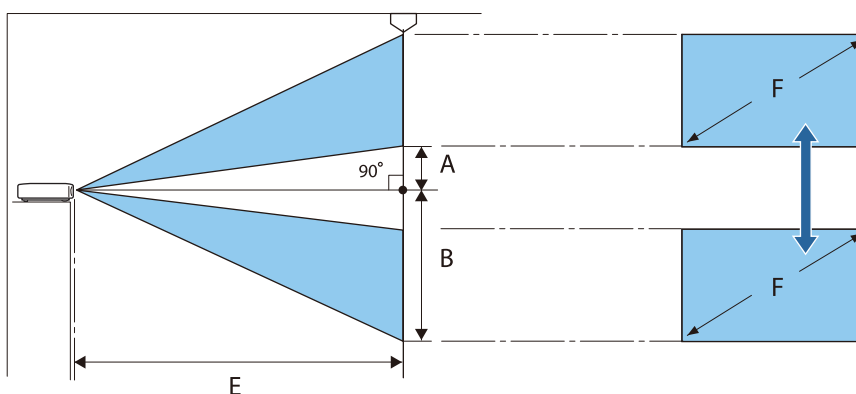

- A : Distance from the center of the lens to the bottom edge of the projected image (when lens shift is raised to its highest level)
- B : Distance from the center of the lens to the bottom edge of the projected image (when lens shift is lowered to its lowest level)
- E : Projection distance from the projector to the screen
- F : Size of the projected image

When adjusting the projection position horizontally in lens shift

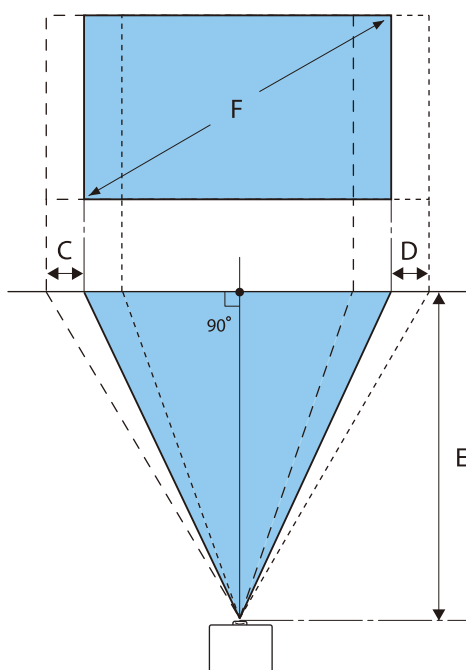

- C : Lens center movement distance when the projector is moved (when lens shift is set to maximum left)

- D : Lens center movement distance when the projector is moved (when lens shift is set to maximum right)
- E : Projection distance from the projector to the screen
- F : Size of the projected image

Unit: cm

16:9 Screen Size		Projection Distance (E)		Lens Shift Maximum Values*		
F	W x H	Minimum (Wide)	Maximum (Tele)	Distance (A)	Distance (B)	Distance (C, D)
40"	89 x 50	116	189	5	55	21
60"	133 x 75	175	285	7	82	32
80"	177 x 100	235	381	10	110	43
100"	221 x 125	295	477	12	137	53
120"	266 x 149	354	574	15	164	64
150"	332 x 187	444	718	19	205	80
200"	443 x 249	593	958	25	274	106

* Vertical and horizontal lens shift cannot both be set to their maximum values.  [p.29](#)

Installation example (with 16:9 screen size and 100")

Side view

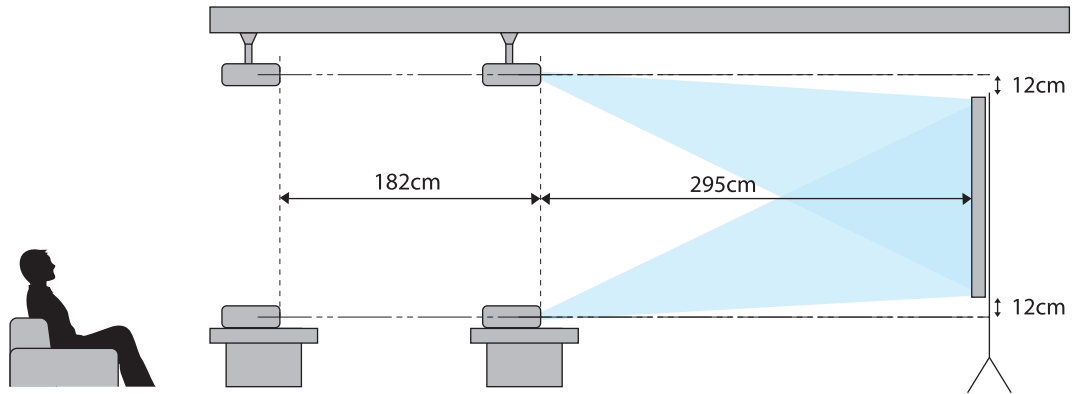

Overhead view

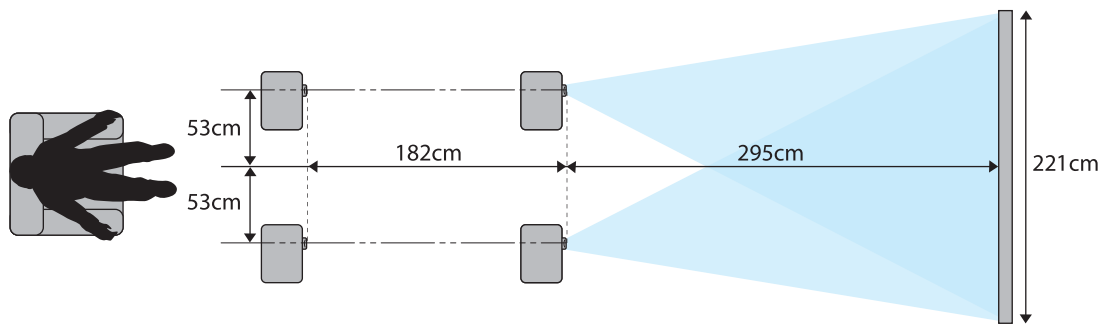

Connecting a Device

Attention

- Make cable connections before connecting to a power outlet.
- Check the shape of the cable's connector and the shape of the port, and then connect. If you force a connector of a different shape into the port, it could cause damage and a malfunction to occur.

Connecting Video Equipment

To project images from DVD/Blu-ray players, connect to the projector using an HDMI cable (commercially available).

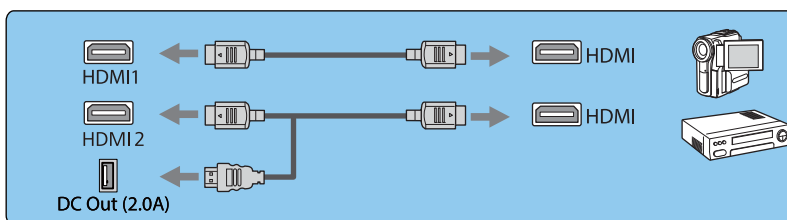
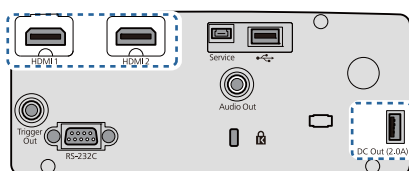

- To display signals in the 18 Gbps transmission band, such as 4k60p/4:4:4, use a premium HDMI cable. If you use a cable that does not support it, images may not be displayed properly. If you experience any trouble displaying images at 18 Gbps, change the EDID setting to **Normal**. **Signal - Advanced - EDID p.61**
- You can also connect your AV system to enjoy the audio from connected equipment.
- When using the power supply port for an optical HDMI cable, connect it to the DC Out (2.0A) power supply port.

Connecting a Computer

To project images from a computer, connect to the projector using an HDMI cable (commercially available).

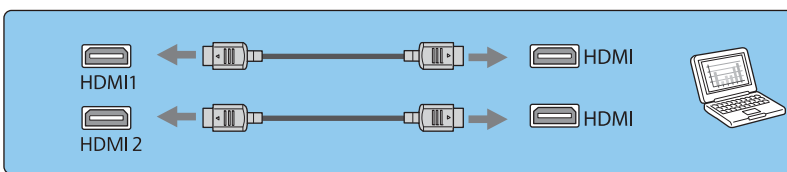
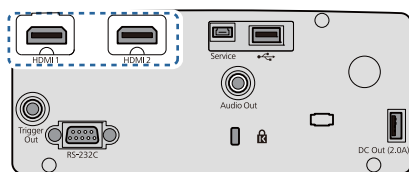

Connecting External Equipment

Connecting to the Trigger Out port (EH-TW7100 only)

To connect external devices such as motorized screens, connect a mini-jack stereo cable (3.5 mm) to the Trigger Out port. When set to on, a signal (12 V DC) is output from this port to communicate the projector's status (On or Off) to connected devices such as electric screens.



- When using the **Trigger Out** port, set the **Trigger Out** function to **Power** or **Anamorphic Wide**. **Extended - Operation - Trigger Out p.65**

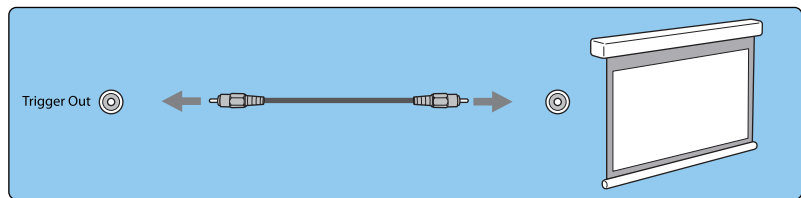
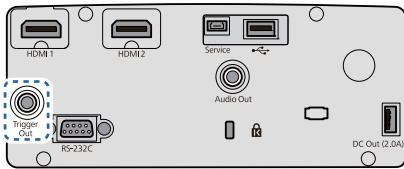

■ Connecting Bluetooth® devices

Audio input to the HDMI1 port or HDMI2 port is output from speakers or headphones that support Bluetooth.

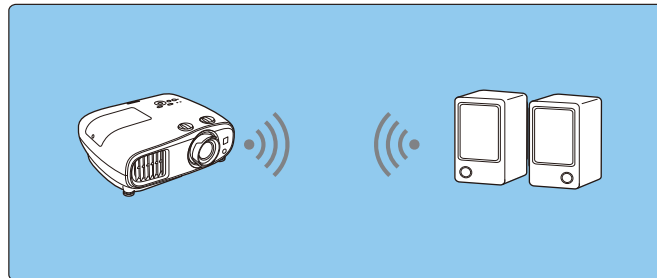

1 Press the [Menu] button to display menus in the order **Settings - HDMI Link - Audio Out Device**.

2 Use the up and down buttons to select **Projector**, and then press the [Enter] button to confirm the selection.

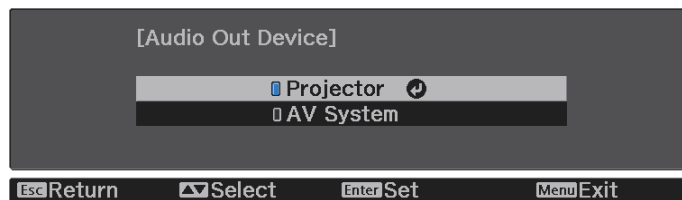

3 Display menus in the order **Settings - Bluetooth - Bluetooth Audio**.

4 Use the up and down buttons to select **On**, and then press the [Enter] button to confirm the selection.



5 Turn on "pairing mode" on the Bluetooth device you want to connect to. See the documentation supplied with the Bluetooth device for more information.

6 Select **Search Bluetooth Device**.
A list of available devices is displayed.

- 7 Use the up and down buttons to select the Bluetooth device you want to connect to, and then press the [Enter] button to connect.

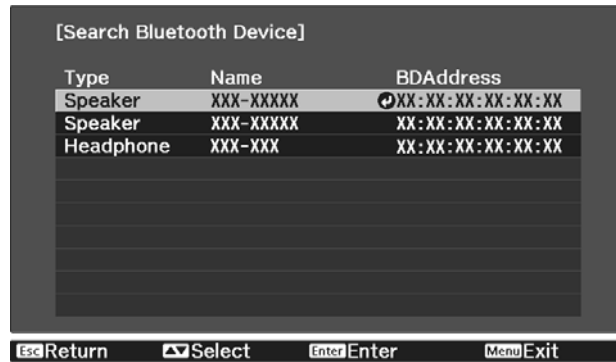

The next time you turn on the projector, it automatically connects to the last device it connected to. To change the connected device, repeat the procedure from step 5.

Bluetooth specifications

Version	Bluetooth Ver. 3.0
Output	Class 2
Communication distance	Approx. 10 m
Supported profiles	A2DP
Content protection	SCMS-T
Frequency used	2.4 GHz band (2.402 to 2.480 GHz)
Supported codecs	SBC, Qualcomm® aptX™ audio

Warning

- Electromagnetic interference may cause medical equipment to malfunction. Before using the device, make sure there is no medical equipment in the vicinity.
- Electromagnetic interference may cause automatically controlled equipment to malfunction which could cause an accident. Do not use the device near automatically controlled equipment such as automatic doors or fire alarms.



- Connect a Bluetooth device that supports copyright protection (SCMS-T).
- You may not be able to connect depending on the standard and type of device.
- Even when connecting within the specified communication distance, connections can be lost due to the status of the signal.
- The communication method for Bluetooth uses the same frequency (2.4 GHz) as wireless LAN (IEEE802.11b/g) or microwave ovens. Therefore, if these devices are used at the same time, radio wave interference may occur, the image and audio may be interrupted, or communication may not be possible. If you do need to use these devices at the same time, make sure there is enough distance between them and the Bluetooth device.
- You cannot connect multiple Bluetooth devices to the projector at the same time.
- There is a delay in the audio output from any Bluetooth audio devices.

Connecting external speakers

To output audio from external speakers, connect the speakers to the projector's Audio Out port with a commercially available audio cable.

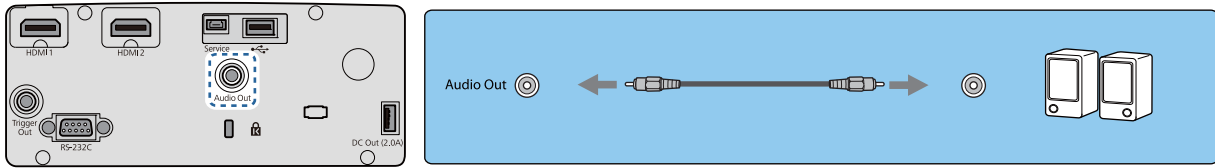

- To output audio from external speakers, set **Audio Out Device** to **Projector**. 🖱️ **Settings - HDMI Link - Audio Out Device** p.62
- When an AV system is not connected to the projector, audio is output from the external speakers, even if **Audio Out Device** is set to **AV System**.

Attaching the Wireless LAN Unit

To use the wireless LAN function, attach an optional Wireless LAN unit (ELPAP10).

Connect the Wireless LAN unit to the USB port.

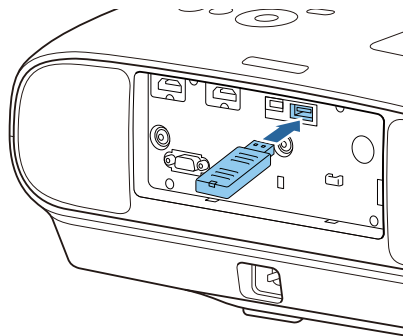

You can use one of the following methods to project over wireless LAN. For more details, see the download page.

- **Projecting four screens simultaneously**

When using Epson iProjection (Windows/Mac), you can display up to four separate screens from the projector from up to 50 computers connected to the network.

You can download Epson iProjection (Windows/Mac) from the following Web site.

<https://www.epson.com>

- **Projecting images from a mobile terminal via a network**

By installing Epson iProjection (iOS/Android) on a smartphone or tablet, you can wirelessly project data on your device. 🖱️ p.54



- When not using the wireless LAN function with the Wireless LAN unit kept inserted, set **Wireless LAN Power** to **Off**. This can prevent unauthorized access from outsiders. 🖱️ p.67
- When using Epson iProjection in **Quick** connection mode, we recommend making security settings. 🖱️ p.69

Preparing the Remote Control

Installing the Remote Control Batteries

Attention

- Check the positions of the (+) and (-) marks inside the battery holder to ensure the batteries are inserted the correct way.
- You cannot use other batteries except for the AA size manganese or alkaline.

- 1** Remove the battery cover.
While pushing the battery compartment cover catch, lift the cover up.

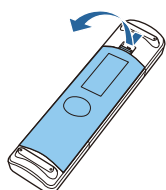

- 2** Replace the old batteries with new batteries.
Check the polarity of the batteries (+) and (-) before installing.

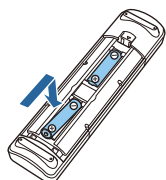

- 3** Reattach the battery cover.
Press the cover until it clicks into place.

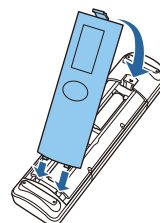

 If delays in the responsiveness of the remote control occur or if it does not operate, it probably means that the batteries are becoming flat. When this happens, replace them with new batteries. Have two AA size manganese or alkaline batteries ready.

Remote Control Operating Range

Operating range (left to right)

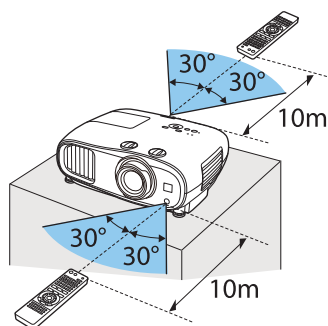

Operating range (top to bottom)

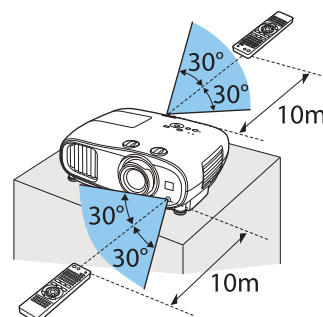

Projecting Images

Turning On the Projector

1 Connect the equipment to the projector.

2 Connect using the power cord supplied.

3 Remove the lens cap.

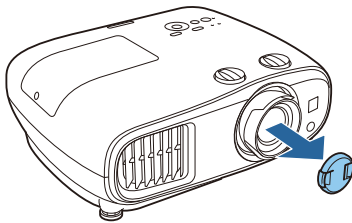

4 Press the power button on the remote control or the standby button on the control panel to turn on the projector.

Remote control

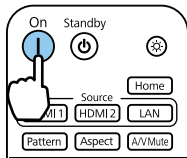

Control panel

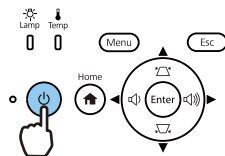

The projector's status indicator flashes blue as the projector warms up. Once the projector is warmed up, the standby indicator and the status indicator turn blue.

When **Direct Power On** is set to **On**, you can start projecting by simply connecting the power cord to the projector without having to press any buttons. **Extended - Operation - Direct Power On** [p.65](#)

5 Turn on the connected equipment.

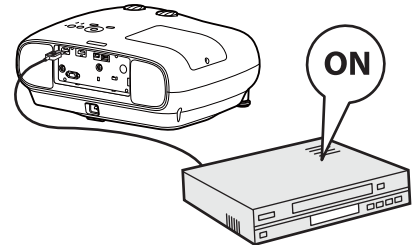

Warning

- Do not look into the lens during projection. The powerful light emitted could cause damage to eyesight. Pay close attention to how your child behaves.
- Do not stand in front of the lens during projection. Clothes could be damaged due to the high temperature.

- This projector provides a Child Lock function to prevent children from accidentally turning the power on and a Control Panel Lock function to prevent accidental operations and so on. **Settings - Lock Setting - Child Lock/Control Panel Lock** [p.62](#)
- When using at an altitude of 1500 m or more, set **High Altitude Mode** to **On**. **Extended - Operation - High Altitude Mode** [p.65](#)

■ If the target image is not projected

If the image is not projected, you can change the source using one of the following methods.

Remote control

Press the button for the target port.

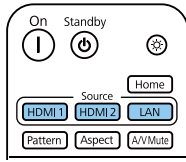

Control panel

Press the [Home] button, and then select the target input source on the home screen displayed.

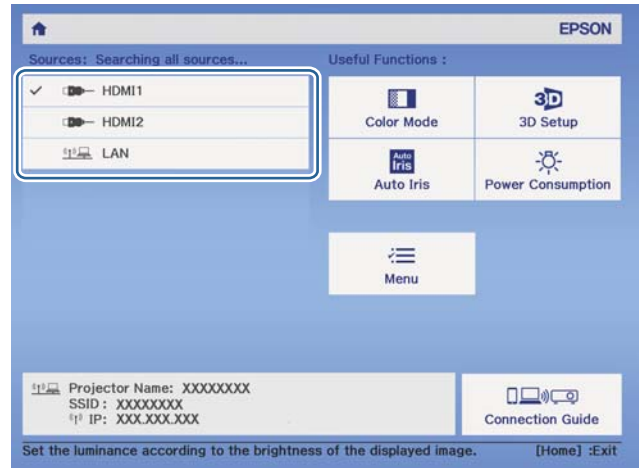

Using the Home Screen

The Home screen feature allows you to easily select an image source and access useful functions. Press the [Home] button on the remote control or the control panel to display the Home screen. Under the following conditions, the Home screen is displayed automatically when the projector is turned on.

- **Home Screen Auto Disp.** is set to **On**. **Extended - Home Screen - Home Screen Auto Disp.** p.65
- There are no signals from any sources.

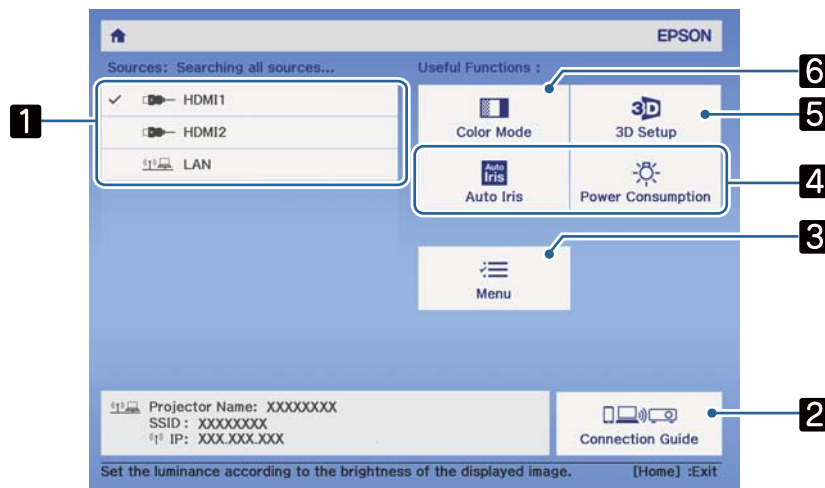

1	Selects the source you want to project.
2	Displays the Connection Guide.
3	Displays the Configuration menu. Extended - Home Screen p.58
4	Performs menu options assigned to Custom Function 1 and Custom Function 2 on the Home Screen . Extended - Home Screen p.65
5	Sets the 3D function. Signal - 3D Setup p.61

6 Selects the **Color Mode**. [p.34](#)



The Home screen disappears after 10 minutes of inactivity.

Turning Off

1 Turn off the connected equipment.

2 Press the standby button on the remote control or the control panel.

Remote control

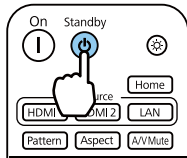

Control panel

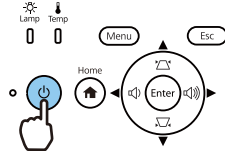

A confirmation message is displayed.

3 Press the standby button again.

Power Off?

Yes : Press button
No : Press any other button

The status indicator flashes and the projector begins to cool down.



When **Standby Confirmation** is set to **Off**, you can turn off the projector by pressing the button on the remote control once.
 Extended - Display - Standby Confirmation [p.65](#)

4 Wait until cool-down is complete.

When cool-down is complete, the status indicator stops flashing.

5 Disconnect the power cord.



- If the power cord is connected, some electricity is consumed even if no operations are made.
- When connecting the power cord again, wait a sufficient time interval.

6 Attach the lens cap.

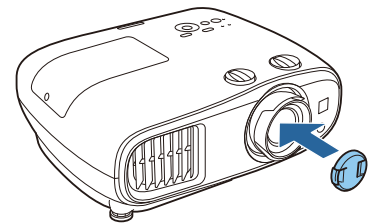



Adjusting the Projected Image



Since images are unstable immediately after the projector is turned on, before you make focus, zoom, or lens shift settings, we recommend waiting 30 minutes or more after starting to project the images.

Displaying the Test Pattern

When adjusting the zoom/focus or the projection position just after setting up the projector, you can display a test pattern instead of connecting video equipment.

Press the [Pattern] button on the remote control to display the test pattern. The standard for horizontal lines at the top and bottom uses 2.40:1 CinemaScope.

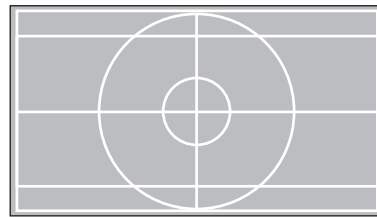
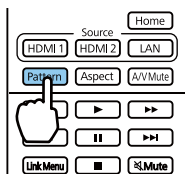

Press the [Pattern] button again to end the test pattern display.

Adjusting the Focus

Turn the focus ring to adjust the focus.

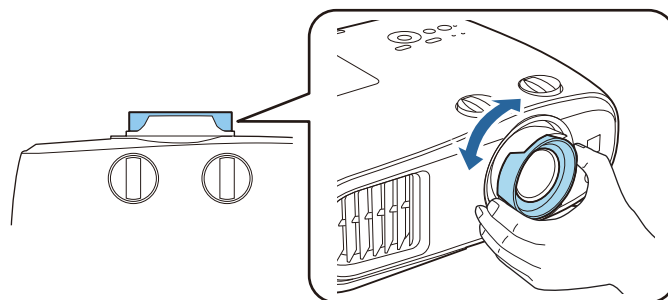

Adjusting the Projection Size (Adjust Zoom)

Grip the knob and turn the zoom ring to adjust the size of the projected image.

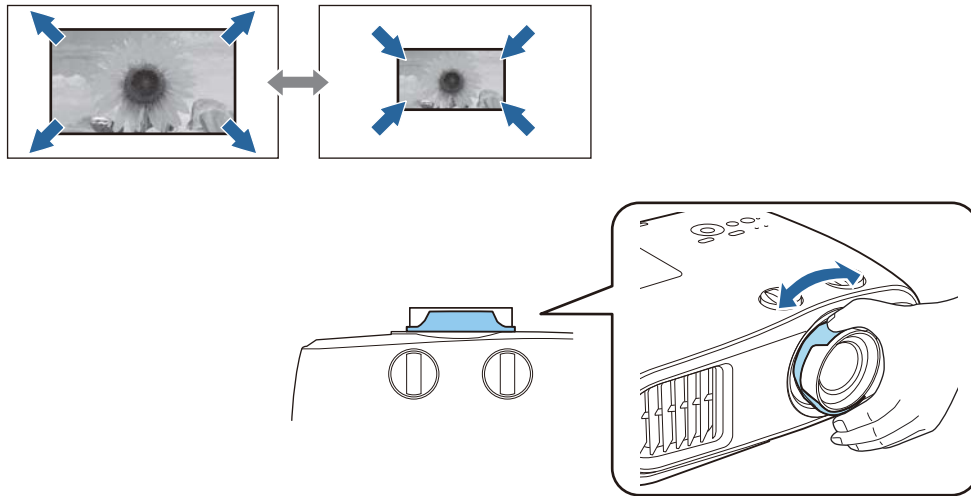

Adjusting the Projector's Tilt

If the projected image is horizontally tilted (the left and right sides of the projected image are at different heights) when the projector is setup on a table, adjust the front foot so that both sides are level with each other.

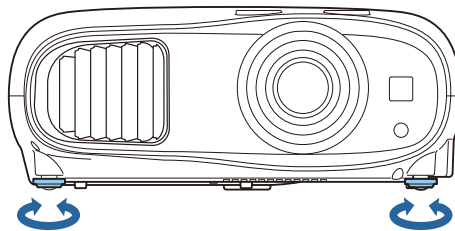

Adjusting the Position of the Image (Lens Shift)

If the projector cannot be installed directly in front of the screen, you can adjust the position of the image by using lens shift.

Turn the vertical and horizontal lens shift dials on the projector to adjust the position of the image. To locate the center of the lens shift range, turn the lens shift dial until you hear it click.

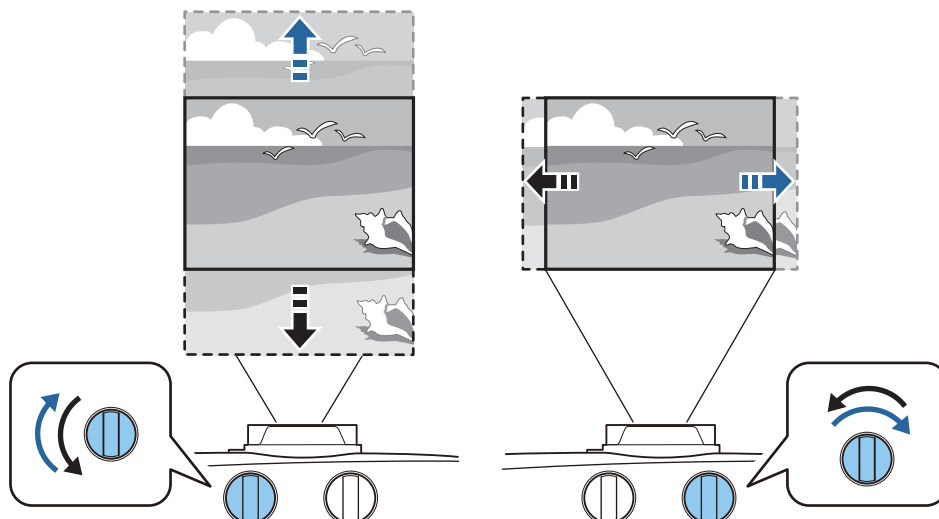

Attention

- When using vertical lens shift for adjusting the position of the image, adjust the image by moving it upward and then finish the adjustment. If you move the image downward and finish the adjustment, its position may lower slightly.
- Do not keep turning the lens shift dials without effect. Once the projection image is positioned all the way to one edge, turning the dial further may impair image quality.



- The sharpest images will be achieved when both of the vertical and horizontal lens shift dials are centered.
- When adjusting the projection position using the lens shift, you are recommended to install the projector in parallel with the screen.

You can move the image within the following range.

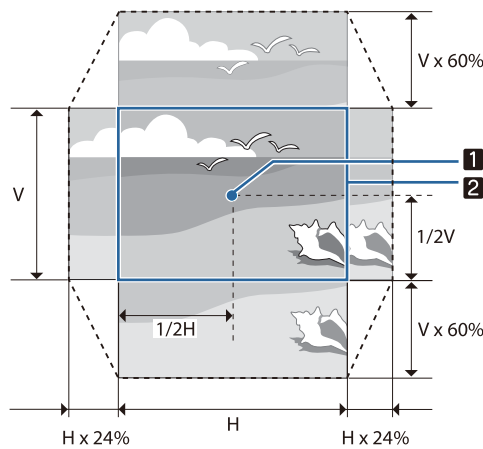

- 1 Center of the lens
- 2 Image with lens shift centered



Caution

When transporting the projector, set the lens position to the center. If you transport the projector when the lens is not in the central position, the lens shift mechanism could be damaged. Also, attach the protective pad that was attached when you purchased it.



When you cannot make adjustments using lens shift, use Keystone to correct the distortion. [p.30](#)

The projected image may be distorted if the lens position is not correct. Therefore, it is recommended that you rotate the lens shift dials to adjust the lens position as shown below, and then use Keystone to adjust distortion in the image.

- Horizontal position of lens: Center
- Vertical position of lens: Top edge

Correcting Keystone Distortion

If you place the projector at an angle to the screen, or tilt it up or down, or off to the side, you may need to correct the distortion in the image.

You can correct it by using one of the following two methods.

- Correct the vertical and horizontal distortion [p.31](#)

- Correct the corners of the projected image individually  [p.32](#)

■ Correct using the Keystone button

You can use the up/down/left/right buttons on the control panel to correct vertical and horizontal keystone distortion.

Press the up or down button to display the V-Keystone/H-Keystone gauges.

When the gauges are displayed, press the up and down buttons to perform vertical correction, and press the left and right buttons to perform horizontal correction.

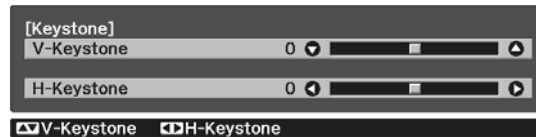

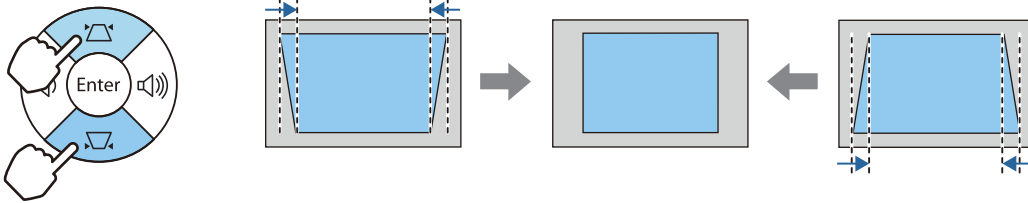

When the top or bottom is too wide

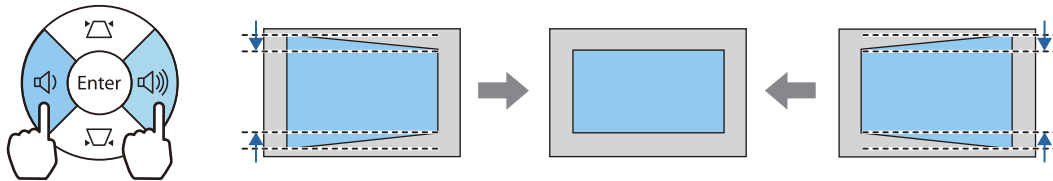

When the left or right is too wide



- When you correct keystone distortion, the projected image may be reduced. Increase the projection distance to fit the projected image to the screen size.
- You can also set H/V-Keystone from the Configuration menu.  **Settings - Keystone - H/V-Keystone** [p.62](#)
- You can make effective corrections within a projection angle range of 30° in any direction.
- You can adjust the volume by pressing the Volume (Left/Right) buttons when the V-Keystone/H-Keystone gauges are not displayed. (EH-TW7100 only)  [p.33](#)

■ Correcting with Quick Corner

You can use the projector's Quick Corner setting to correct the shape and size of an image that is unevenly rectangular.

- 1 Press the [Menu] button to display menus in the order **Settings - Keystone**.

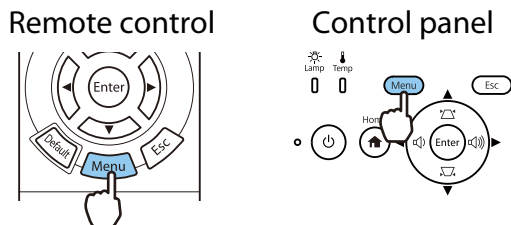

- 2 Use the up and down buttons to select **Quick Corner**, and then press the [Enter] button. Press the [Enter] button again if necessary.

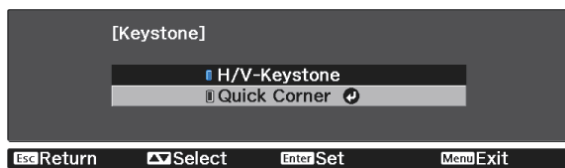

The area selection screen is displayed.

- 3 Use the up/down/left/right buttons to select the corner of the image you want to adjust. Then press the [Enter] button.

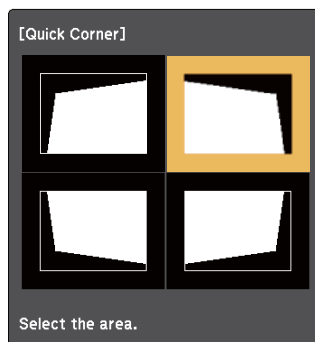

- To reset the Quick Corner corrections, hold down the [Esc] button for about two seconds while the area selection screen is displayed, and then select **Yes**.

- 4 Press the up/down/left/right buttons to adjust the shape of the image as necessary. Press the [Enter] button to return to the area selection screen.

- If you see this screen, you cannot adjust the shape any further in the direction indicated by the gray triangle.

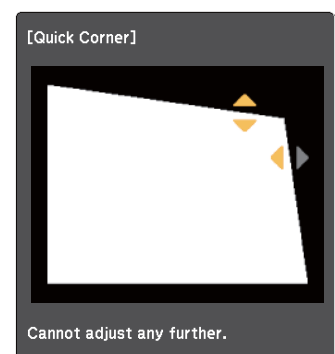

- 5 Repeat steps 3 and 4 as needed to adjust any remaining corners.

- 6 When you are finished, press the [Esc] button.

- After executing Quick Corner, the **Keystone** setting is now set to **Quick Corner** in the projector's **Settings** menu. When you press the up or down button on the control panel, the area selection screen is displayed.

Adjusting the Volume

You can control the volume using the [Volume] buttons on the remote control, or the Volume buttons on the control panel (EH-TW7100 only).

Remote control

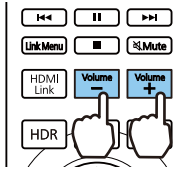

Control panel

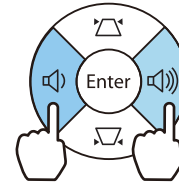

- You can also adjust the volume from the Configuration menu. ➡ **Settings - Audio - Volume** p.62
- When an AV System is connected to the projector and you want to adjust the volume for the AV system, set **HDMI Link** to **On** and **Audio Out Device** to **AV System**. ➡ **Settings - HDMI Link** p.62



Caution

Do not start at high volume.

A sudden excessive volume may cause loss of hearing. Always lower the volume before powering off, so that you can power on and then gradually increase the volume.

Hiding the Image and Muting the Audio Temporarily (A/V Mute)

Press the [A/V Mute] button on the remote control to show or hide the image. The audio is also muted or played.

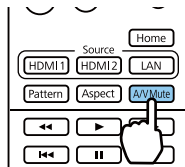

- For movies, the image and audio continue to play even during A/V Mute. You cannot resume from the point that you muted the video and audio using the [A/V Mute] button.
- To mute or play only the audio, press the [Mute] button.
- When outputting audio from an AV system and you want to adjust the volume for the AV system, set **HDMI Link** to **On** and **Audio Out Device** to **AV System**. ➡ **Settings - HDMI Link** p.62



Adjusting the Image

Selecting the Projection Quality (Color Mode)

You can obtain the optimum image quality to suit your surroundings when projecting. The brightness of the image varies depending on the mode selected.

1 Press the [Color Mode] button.

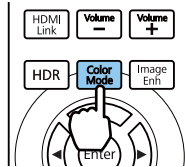

- You can make settings from the Configuration menu. **Image - Color Mode** p.59
- If you press the [Home] button, you can also make settings from the Home screen. p.26

2 Select **Color Mode**.

Use the up and down buttons to select a mode, and then press the [Enter] button to confirm the selection.

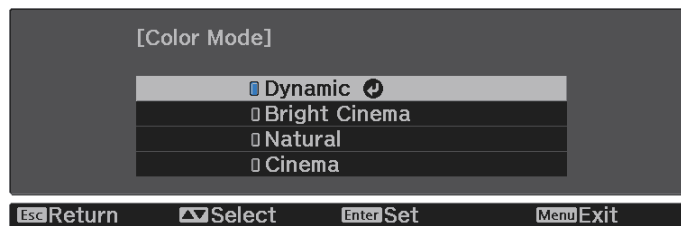

Mode	Application
Dynamic	This is the brightest mode. Best for prioritizing brightness.
Bright Cinema	Best for projecting vivid images.
Natural	Best for faithfully reproducing the color of the source image. We recommend selecting this mode when performing color adjustment for the image. p.40
Cinema	Best for enjoying content such as movies.

Switching the Screen Between Full and Zoom (Aspect)

You can change the input signal's type, aspect ratio, and resolution to match the **Aspect** of the projected image.

The available settings vary depending on the image signal currently being projected.



Note that using the aspect ratio function of the projector to reduce, enlarge, or split the projected image for commercial purposes or for public viewing may infringe upon the rights of the copyright holder of that image based on copyright law.

1 Press the [Aspect] button.

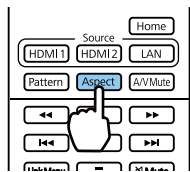

You can make settings from the Configuration menu. **Signal - Aspect** p.61

2 Use the up and down buttons to select the item, and then press the [Enter] button to confirm the selection.

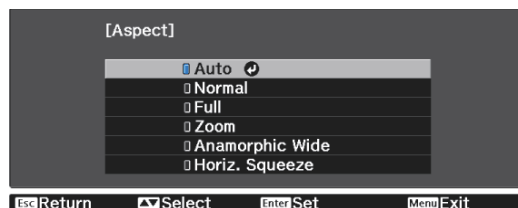

- You cannot switch the **Aspect** when the Source is LAN. Also, when the Source is HDMI1/HDMI2, you may not be able to change the **Aspect** depending on the input signal.
- Anamorphic Wide** and **Horiz. Squeeze** are only displayed for the EH-TW7100.

By normally selecting **Auto**, the optimum aspect is used to display the input signal. Change the setting if you want to use a different aspect.

The table below shows the image projected on a 16:9 screen.

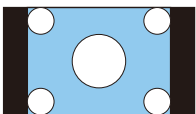
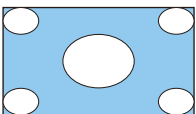
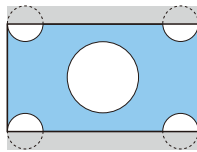
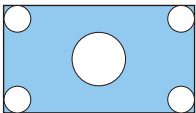
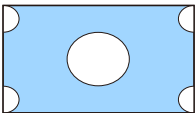
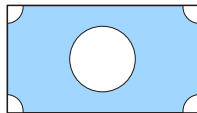
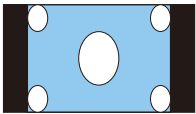
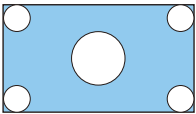
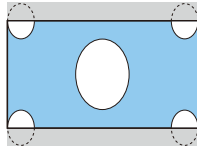
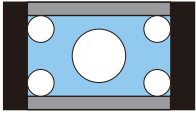
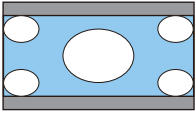
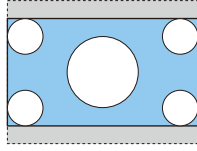
Input Image	Setting Name		
	Normal	Full	Zoom
4:3 Images			
16:9 Images*1			
Images Recorded Using Squeeze			
Letterbox Images*2			
Notes	Matches the vertical size of the projection panel. The aspect ratio differs depending on the input image.	Uses the entire projection panel. The aspect ratio differs depending on the input resolution.	Retains the aspect ratio of the input signal, and matches the horizontal size of the projection panel. The top and bottom of the image may be truncated.

*1 When inputting a 16:9 signal, **Full** and **Zoom** cannot be used for 4K and 3D signals.

*2 The letterbox image used in this explanation is a 4:3 aspect ratio image displayed in 16:9 with black margins at the top and bottom for subtitle placement. The margins at the top and bottom of the screen image are used for subtitles.

Set **Anamorphic Wide** and attach a commercially available anamorphic lens to enjoy DVDs, Blu-rays, and so on of images recorded at Cinema Scope size.

Horiz. Squeeze stretches the horizontal aspect of the input signal. This allows you to project across the full width of the screen when using a commercially available anamorphic lens.



- If **Anamorphic Wide** is selected when **Overscan** is set, the image may be truncated. Set **Overscan** to **Off**. **Signal - Overscan** p.61
- When projecting 3D images in **Anamorphic Wide**, only 1080p/24 Hz/frame packing signals are supported.
- When a 4K image signal is being input, you can only select **Normal**, **Anamorphic Wide**, and **Horiz. Squeeze**.

Adjusting the Sharpness

You can make the image clearer.

The following shows the setting items and procedures.

Standard	Enhances the outlines for the projected image overall. When you adjust Standard , the adjustment values for Thin Line Enhancement and Thick Line Enhancement are also adjusted.
Thin Line Enhancement	Details such as hair and patterns on clothing are enhanced.
Thick Line Enhancement	Rough parts such as outlines for entire subjects or the background are enhanced, making the overall image clearer.

1 Press the [Menu] button.

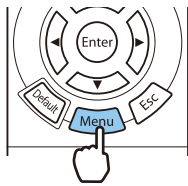

The Configuration menu is displayed.

2 Select **Image - Sharpness**.

The **Sharpness** adjustment screen is displayed.

3 Use the up and down buttons to select the item, and then use the left and right buttons to make the adjustments.

The image is enhanced when moved to the right (positive) and softer when moved to the left (negative).



Press the [Default] button to return the adjustments to their default values.

4 Press the [Menu] button to exit the menu.

Adjusting Image Resolution (Image Enhancement)

You can adjust the resolution of the image using the Image Enhancement function.

The following content can be adjusted.

4K Enhancement*3	4K Enhancement is a function that projects an image at a doubled resolution by diagonally shifting 1 pixel in increments of 0.5 pixels. A high-resolution image signal is projected in fine detail.
Image Preset Mode	Select the settings prepared in advance as the settings for Noise Reduction , MPEG Noise Reduction , Super-resolution , and Detail Enhancement .
Frame Interpolation*1 *2 *3	Plays movies smoothly.  p.38
Deinterlacing*1 *2	Converts the signal from interlaced to progressive using a method appropriate for the image signal.
Noise Reduction*1 *2 *3	Smooths out rough images.
MPEG Noise Reduction*1 *2 *3	You can reduce dot and block noise that occurs in outlines when projecting MPEG movies.
Super-resolution*2	Fine Line Adjust: Enhances the contrast and the outlines of complicated images. Soft Focus Detail: Enhances the contrast and the outlines for smooth backgrounds.
Detail Enhancement*2	Enhances the contrast in an image to create a more emphatic texture and material feel. Strength: The larger the value, the stronger the contrast. Range: The larger the value, the wider the range of detail enhancement becomes.

*1 This can only be set when **Signal - Advanced- Image Processing** is set to **Fine**.

*2 This can be set at any time except when **Image Preset Mode** is set to **Off**.

*3 This cannot be set when 4K signals are being input.

1 Press the [Image Enh] button.

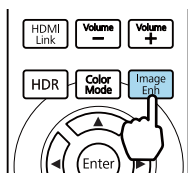

You can make settings from the Configuration menu.  **Image - Image Enhancement** [p.59](#)

2 Use the up and down buttons to select the item you want to adjust, and then press the [Enter] button to confirm the selection.

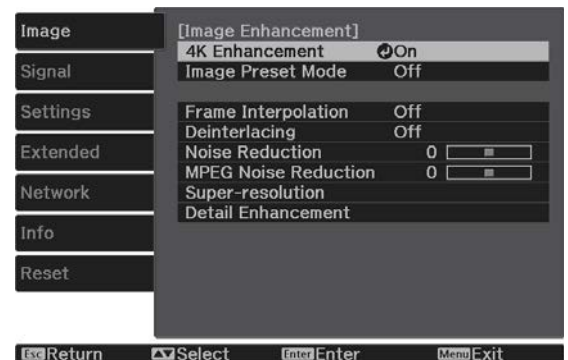

- 3 Use the left and right buttons to make adjustments.

Press the [Esc] button to adjust another item.

Press the [Default] button to return the adjustments to their default values.



- 4 Press the [Image Enh] button to exit the menu.

Setting Auto Iris

By automatically setting the luminance according to the displayed image, you can enjoy deep and rich images. You can select the luminance adjustment tracking for changes in brightness in the displayed image from **Normal** to **High Speed**.

- 1 Press the [Auto Iris] button.

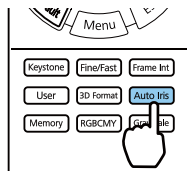

You can make settings from the Configuration menu. **Image - Auto Iris** [p.59](#)

- 2 Use the up and down buttons to select the item, and then press the [Enter] button to confirm the selection.

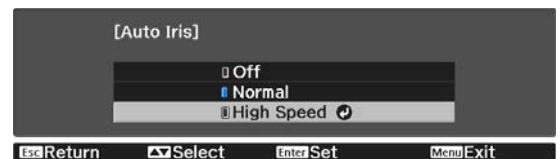

Depending on the image, you may hear the Auto Iris operating, but this is not a malfunction.

Setting Frame Interpolation

You can play fast moving images smoothly by automatically producing intermediate frames between the original frames.

Frame Interpolation is available under the following conditions.

- When **Image Processing** is set to **Fine**. **Image - Signal - Advanced - Image Processing** [p.61](#)
- When the source is HDMI1 or HDMI2.
- When inputting 2D signals* or 3D signals (1080p 24 Hz). [p.95](#)

* This is unavailable when a 4K signal is being input. This is enabled only when **4K Enhancement** is set to **On** and 1080p 24 Hz signals are being input. **Image - Image Enhancement - 4K Enhancement** [p.59](#)

1

Press the [Frame Int] button.

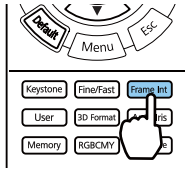

You can make settings from the Configuration menu. **Image - Image Enhancement - Frame Interpolation** p.59

2

Use the up and down buttons to select the item, and then press the [Enter] button to confirm the selection.



Setting the Image Processing Speed

Improves the response speed for images projected at high-speed, such as games.

This is only available when receiving a progressive signal input from the HDMI1 or HDMI2 ports.

Press the [Fine/Fast] button to switch between **Fine** and **Fast**.

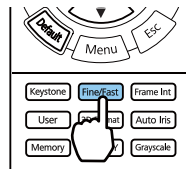

- You can make settings from the Configuration menu. **Signal - Advanced - Image Processing** p.61
- This does not support 3D images.
- When **Image Processing** is set to **Fast**, **Noise Reduction**, **Frame Interpolation**, **Deinterlacing**, and **MPEG Noise Reduction** are fixed at Off.



Adjusting the Color

Adjusting the Color Temp.

Adjusts the tint for the images. Make adjustments if the image is a little too blue or too red and so on.

Press the [Menu] button to display menus in the following order.

Image - White Balance - Color Temp.

Use the left and right buttons to make adjustments. Blue tints grow stronger as the value is increased, and red tints grow stronger as the value is reduced.



Press the [Default] button to return the adjustments to their default values.

Adjusting the RGB (Offset and Gain)

You can adjust the brightness of dark areas (Offset) and bright areas (Gain) for R (red), G (green), and B (blue).

Press the [Menu] button to display menus in the following order.

Image - White Balance - Custom

Use the up and down buttons to select the item, and then use the left and right buttons to make the adjustments. The image becomes brighter when moved to the right (positive) and darker when moved to the left (negative).

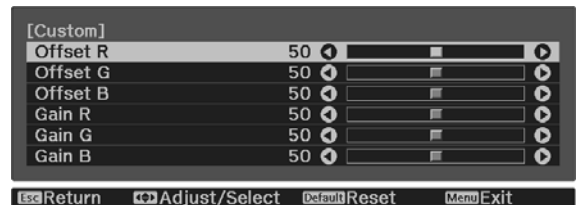

Offset	When the image is made brighter, shading for the darker sections is more vividly expressed. When the image is made darker, the image appears more full-bodied but shading for the darker sections is harder to distinguish.
Gain	When the image is made brighter, the bright sections become whiter and shading is lost. When the image is made darker, shading for the bright sections is more vividly expressed.



Press the [Default] button to return the adjustments to their default values.

Adjusting Hue, Saturation, and Brightness

You can adjust the hue, saturation, and brightness for each of the R (red), G (green), B (blue), C (cyan), M (magenta), and Y (yellow) colors.

Hue	Adjusts the overall color of the image to be blue, green, or red.
Saturation	Adjusts the overall vividness of the image.
Brightness	Adjusts the overall color brightness of the image.

1 Press the [RGBCMY] button.

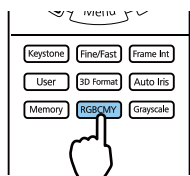

You can make settings from the Configuration menu. **Image - Advanced - RGBCMY** [p.59](#)

2 Use the up and down buttons to select the color you want to adjust, and then press the [Enter] button to confirm the selection.

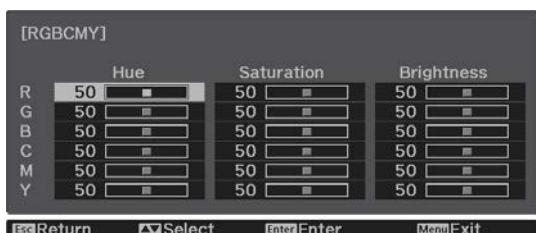

3 Use the up and down buttons to select **Hue, Saturation, or Brightness**.

4 Use the left and right buttons to make adjustments.

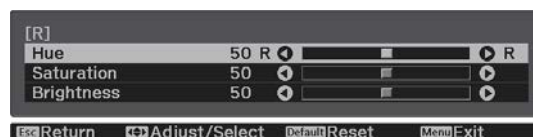

Press the [Esc] button to adjust another color.

Press the [Default] button to return the adjustments to their default values.

5 Press the [RGBCMY] button to exit the menu.

Adjusting the Gamma

You can adjust slight coloration differences that may occur due to the device being used when the image is displayed.

You can set it by using one of the following methods.

- Select and adjust the correction value
- Adjust using the gamma adjustment graph

■ Select and adjust the correction value

1 Press the [Menu] button to display menus in the following order.
Image - Advanced - Gamma

2 Use the up and down buttons to select the correction value, and then press the [Enter] button to confirm the selection.

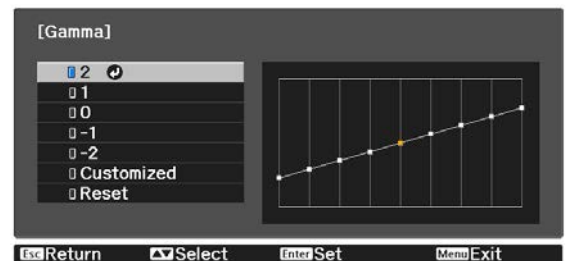

The larger the value, the lighter the dark portions of the image become, but bright areas may appear discolored. The upper part of the gamma adjustment graph becomes rounded.

The smaller the value, the darker the bright portions of the image become. The lower part of the gamma adjustment graph becomes rounded.



- The horizontal axis of the gamma adjustment graph shows the input signal level, and the vertical axis shows the output signal level.
- Select **Reset** to return the adjustments to their default values.

■ Adjust using the gamma adjustment graph

Select a tone point on the graph and make adjustments.

1 Press the [Menu] button to display menus in the following order.
Image-Advanced-Gamma-Custom

- 2 Use the left and right buttons to select the tone you want to adjust from the graph.

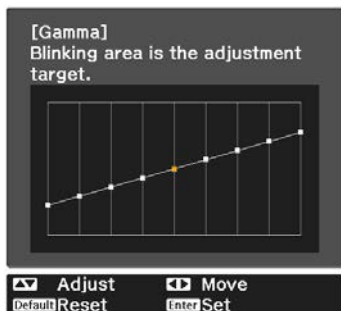

- 3 Use the up and down buttons to adjust the brightness, and then press the [Enter] button to confirm the selection.

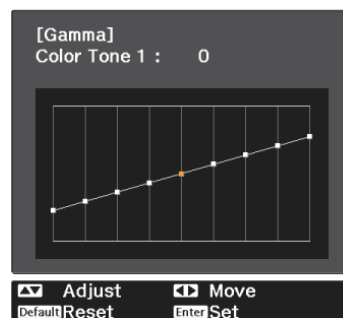

Viewing the Image at the Saved Image Quality (Memory Function)

Saving a Memory

By using the memory function, you can register settings for **Image** from the Configuration menu, and then load them when necessary.

1 Make the settings or adjustments you want to register.

2 Press the [Memory] button.

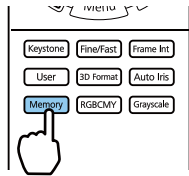

3 Use the up and down buttons to select **Save Memory**, and then press the [Enter] button to confirm the selection.



4 Use the up and down buttons to select the memory name you want to save, and then press the [Enter] button to confirm the selection.

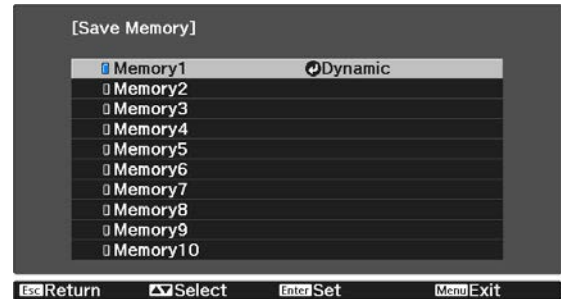

The current projector settings are saved to the memory.

If the mark on the left of the memory name is turned aqua, it means the memory has already been registered. When you select a registered memory, a message is displayed asking you to confirm that you want to overwrite the memory. If you select **Yes**, the previous content is erased and the current settings are saved.

Loading, Deleting, and Renaming a Memory

You can load, delete, and rename registered memories.

Press the [Memory] button, and then select the target function on the screen displayed.

Function	Explanation
Load Memory	Loads the saved memory. When you select a memory and press the [Enter] button, the settings applied to the current image are replaced with the settings from the memory.
Erase Memory	Erases a saved memory. When you select a memory name and press the [Enter] button, a message is displayed. Select Yes , and then press the [Enter] button to erase the selected memory.

Function	Explanation
Rename Memory	<p>Changes the memory name. Select the memory name you want to change, and then press the [Enter] button. Enter the memory name using the soft keyboard.  p.68</p> <p>When you have finished, move the cursor over Finish, and then press the [Enter] button.</p>

Enjoying 3D Images

Preparing to View 3D Images

To view 3D images, be sure to prepare a pair of commercially available 3D Glasses with an active shutter system that supports radio waves (RF/Bluetooth) communication system in advance.

Check the following before viewing 3D images.

- Set the source to HDMI1 or HDMI2.
- Set **3D Display** to **Auto** or **3D**.  **Signal - 3D Setup - 3D Display** p.61
- Pair 3D Glasses.

This projector supports the following 3D formats.

- Frame Packing
- Side by Side
- Top and Bottom

■ If the 3D image cannot be viewed

The projector automatically projects a 3D image when detecting a 3D format.

Some 3D TV broadcasts may not contain 3D format signals. If this happens, follow the steps below to set the 3D format.

1 Press the [Menu] button to display menus in the order **Signal - 3D Setup**.

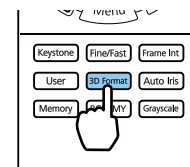

2 Set **3D Display** to **3D**.

3 Press the [3D Format] button to set the 3D format on the AV device.

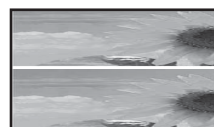
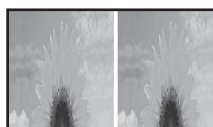

- If you are using a device or cable that does not support 3D images, 3D projection cannot be performed.
- For details on 3D format settings on the AV device, see the documentation supplied with the AV device.
- When the 3D format has not been correctly set up, an image will not be correctly projected as shown below.



- If a 3D image is not projected correctly even when a 3D format is set, the synchronization timing for the 3D Glasses may be inverted. Inverse the synchronization timing using **Inverse 3D Glasses**.  **Signal - 3D Setup - Inverse 3D Glasses** p.61
- How a 3D image is perceived varies depending on the individual.
- When you start projecting a 3D image, a warning about viewing 3D images is displayed. You can turn off this warning by setting **3D Viewing Notice** to **Off**.  **Signal - 3D Setup - 3D Viewing Notice** p.61
- During 3D projection, the following Configuration menu functions cannot be changed. 4K Enhancement, Frame Interpolation, Aspect (except for Normal/Anamorphic Wide), Overscan (set to Off), Super-resolution, Image Processing, Advanced - Dynamic Range
- How the 3D image is viewed may change depending on the temperature of the surroundings and how long the lamp has been used. Refrain from using the projector if the image is not projected normally.

Using 3D Glasses

You can view 3D images by using a pair of commercially available 3D Glasses (with an active shutter system that supports radio waves (RF/Bluetooth) communication system).

To view 3D images, you first need to pair the 3D Glasses with the projector. See the User's Guide supplied with your 3D Glasses for more information.

Warnings Regarding Viewing 3D Images

Note the following important points when viewing 3D images.

Caution

Viewing Time

- When viewing 3D images, always take periodic breaks during extended viewing. Long periods of viewing 3D images may cause eye fatigue. The amount of time and frequency of such breaks varies from person to person. If your eyes still feel tired or uncomfortable even after taking a break from viewing, stop viewing immediately.

Caution

Watching 3D Images

- If your eyes feel fatigued or uncomfortable when viewing 3D images, stop viewing immediately. Continuing to view the 3D images could cause you to feel unwell.
- When viewing 3D images be sure to always wear 3D Glasses. Do not attempt to view 3D images without 3D Glasses. Doing so could cause you to feel unwell.
- Do not place any breakable or fragile objects around you when using 3D Glasses. 3D images may cause you to move your body involuntarily, resulting in damage to nearby items or personal injury.
- Only wear 3D Glasses when viewing 3D images. Do not move around while wearing 3D Glasses. Your vision may appear darker than normal, causing you to fall or injure yourself.
- Try to stay as level with the viewing screen as possible when viewing 3D images. Viewing 3D images at an angle reduces the 3D effect and may cause you to feel unwell due to unintended color changes.
- When viewing 3D images in a room with fluorescent or LED lighting, you may see flashing or flickering throughout the room. If this should occur, reduce the lighting until the flickering goes away or turn off the lights completely when viewing 3D images. In some very rare cases, this flickering could trigger seizures or fainting for some individuals. If you begin to feel uncomfortable or unwell at any time when viewing 3D images, stop immediately.
- Stay at least three times the height of the screen away from the screen when viewing 3D images. The recommended viewing distance for an 80-inch screen is at least 3 meters, and at least 3.6 meters for a 100-inch screen. Sitting or standing any closer than the recommended viewing distance may result in eye fatigue.

 Caution

Health Risks

- You should not use 3D Glasses if you are sensitive to light, have a heart condition, or are unwell. Doing so could aggravate your pre-existing conditions.

 Caution

Recommended Age of Use

- The minimum recommended age to view 3D images is six years old.
- Children under the age of six are still developing and viewing 3D images may cause complications. Consult your doctor if you have any concerns.
- Children viewing 3D images through 3D Glasses should always be accompanied by an adult. It is often difficult to tell when a child is feeling tired or uncomfortable, which could result in them feeling suddenly unwell. Always check with your child to ensure that they are not experiencing any eye fatigue during viewing.

Using the HDMI Link Function

HDMI Link Function

When an AV device that meets the HDMI CEC standards is connected to the projector's HDMI port, you can perform linked operations such as linked power on and volume adjustment for the AV system from one remote control.

- As long as the AV device meets the HDMI CEC standards, you can use the HDMI link function even if the AV system in-between does not meet the HDMI CEC standards.
- Up to 2 multi-media players that meet the HDMI CEC standards can be connected at the same time.

Connection Example

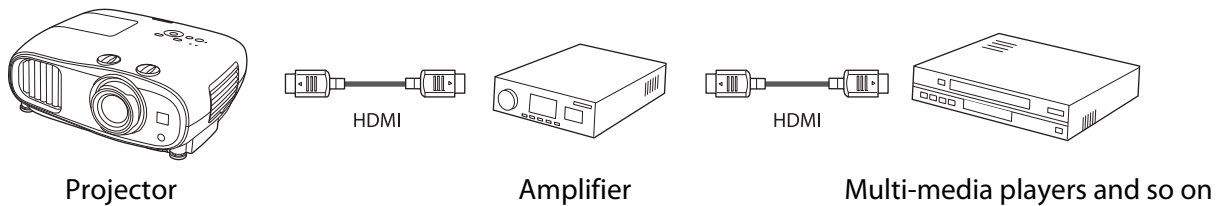

HDMI Link Settings

When **HDMI Link** is set to **On**, you can perform the following operations. **Settings - HDMI Link - HDMI Link p.62**

- Input Change Link**
Changes the input source of the projector to HDMI when content is played back on the connected device.
- Connected Devices Operations**
Using the projector's remote control, you can perform operations such as Play, Stop, Fast Forward, Rewind, Next Chapter, Previous Chapter, Pause, Volume Adjustment, and Audio Mute.

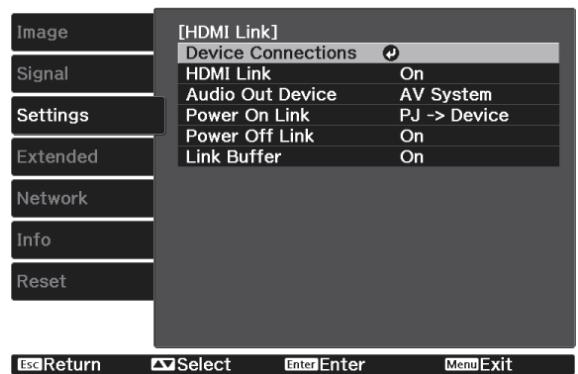

You can also select the following functions from the **HDMI Link** screen.

Function	Explanation
Audio Out Device	<p>Selects which device outputs audio.</p> <p>Projector: Outputs audio from the projector's built-in speakers (EH-TW7100 only) or from an external speaker connected to the Audio Out port.</p> <p>AV System: Select this to output audio from an AV amplifier that supports the HDMI CEC standards.</p>
Power On Link	<p>When Power On Link is set, operations are linked as shown below.</p> <ul style="list-style-type: none"> When the projector is turned on, the connected devices are also turned on. Also, when the connected devices are turned on and content is played back, the projector turns on.

Function	Explanation
Power Off Link	<p>When Power Off Link is set to On, when the projector is turned off, the connected devices are also turned off.</p> <ul style="list-style-type: none"> • This only works when the connected device's CEC power link function is enabled. • Note that depending on the status of the connected device (for example, if it is recording), the device may not power off.
Link Buffer	<p>If HDMI Link is not working correctly, you may be able to improve it by changing the settings.</p>

 To use the HDMI Link function, you must configure the connected device. See the documentation supplied with the connected device for more information.

Connecting

You can check the connected devices that are available for HDMI Link, and select on the device you want to project the image from. Devices that can be controlled by HDMI Link automatically become the selected device.

Before displaying the list of connected devices, check that **HDMI Link** is set to **On**.  **Settings - HDMI Link - HDMI Link** [p.62](#)

1 Press the [HDMI Link] button, and then select **Device Connections**.

The **Device Connections** list is displayed.

Devices that have an aqua icon to their left are linked by HDMI Link.

If the device name cannot be determined this field is left blank.

2 Select the device you want to operate using the HDMI Link function.

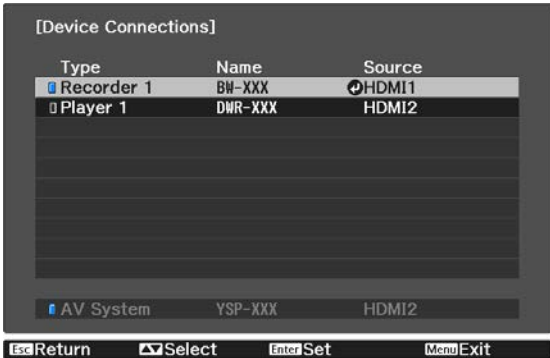

 • If the cable does not meet the HDMI standards, operations are not possible.

• Some connected devices or functions of those devices may not operate properly even if they meet the HDMI CEC standards. See the documentation and so on supplied with the connected device for more information.

Projecting Using Wireless LAN

You can project images from smartphones, tablets, and computers over wireless LAN.

To project over wireless LAN, you need to make wireless network settings for the projector and the connected device in advance.

Use Epson iProjection to project images over wireless LAN. You can download Epson iProjection using any of the following methods; however, the customer is liable for any costs involved.

- You can download Epson iProjection (Windows/Mac) from the following Web site.
<https://www.epson.com>
- You can download Epson iProjection (iOS/Android) from the App Store or Google Play.

Selecting Wireless Network Settings Manually

Before you can project from your wireless network, you need to select network settings for the projector.

1 Press the [Menu] button to display menus in the order **Network - Wireless LAN Power**.

2 Use the up and down buttons to select **On**, and then press the [Enter].

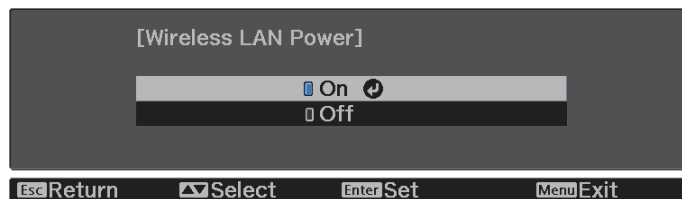

3 Select **Network Configuration**, and then press the [Enter] button.

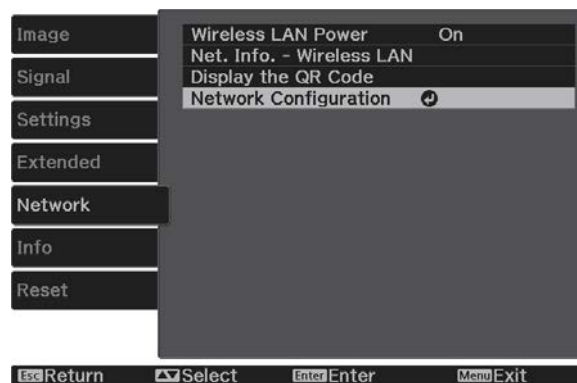

4 Select **Basic**, and then set the following as necessary.

- **Projector Name:** Enter a name up to 16 alphanumeric characters long to identify the projector over the network.
- **Remote Password:** Set a password to use when you operate the projector from a smartphone or a tablet. You can enter up to single-byte 8 alphanumeric characters.
- **Display LAN Info.:** Set the display format for the projector's network information.



Use the displayed keyboard to enter the name, passwords and keyword. Use the up/down/left/right buttons to select characters, and then press the [Enter] button to confirm the selection.

5 Select **Wireless LAN**, and then press the [Enter] button.

6 Select the **Connection Mode** setting.

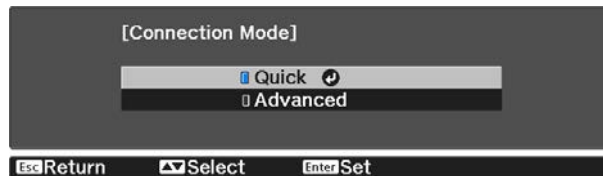

- **Quick:** Lets you connect the projector to your smartphones, tablets, or computers directly using wireless communication. When you select **Quick**, go to step 10.
- **Advanced:** Lets you connect to multiple smartphones, tablets, or computers over a wireless network access point. When you select **Advanced**, go to step 7.

7 Select **Network Configuration - Wireless LAN - Search Access Point**, to select the access point you want to connect to.

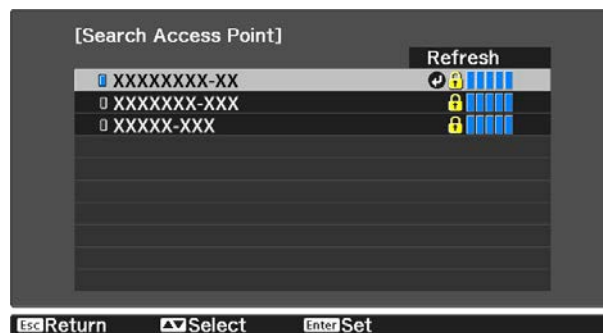

If you need to assign the SSID manually, select **SSID** to enter the SSID. In addition, configure the security settings in the **Security** menu. [p.54](#)

8 Assign an IP address to the projector as necessary.

- If your network uses DHCP, select **IP Settings** to set the **DHCP** setting to **On**.
- If you are not using DHCP, select **IP Settings** to set the **DHCP** setting to **Off**, and then enter the projector's **IP Address**, **Subnet Mask**, and **Gateway Address**.

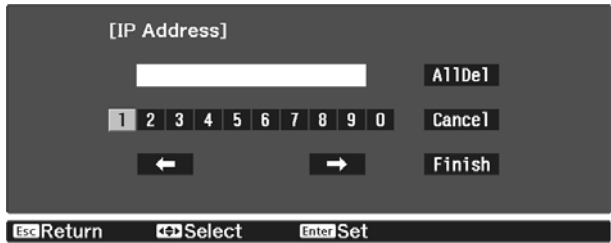

9 When you have finished making settings, select **Complete** and follow the on-screen instructions to save your settings and exit the menus.

10 Press the [LAN] button on the remote control. The settings are complete when you see the correct IP address on the LAN standby screen.

When you have finished making wireless settings for your projector, you need to make wireless settings on the connected device. Then start the network software to send images to your projector through a wireless network.

 To prevent the SSID and IP address from being displayed on the LAN standby screen or the Home screen, set **SSID Display** and **IP Address Display** to **Off**. **Network - Network Configuration - Wireless LAN** [p.69](#)

Selecting the Computer's Wireless LAN Settings

Before connecting to the projector, select the correct wireless network on your computer.

Selecting wireless network settings in Windows

- 1 To access your wireless utility software, double-click the network icon on the Windows taskbar.
- 2 When connecting in Advanced connection mode, select the network name (SSID) of the network the projector is connecting to.
- 3 Click **Connect**.

Selecting wireless network settings in OS X

- 1 Click the AirMac icon on the menu bar at the top of the screen.

- 2 When connecting in Advanced connection mode, make sure AirMac is turned on and select the network name (SSID) of the network the projector is connecting to.

Setting Up Wireless Network Security

You can set up security for your projector to use on a wireless network. Set up one of the following **Connection Mode** to match the settings used on your network:

- WPA2 security
- WPA/WPA2 security

- 1 Press the [Menu] button to display menus in the order **Network - Network Configuration - Security**.

- 2 Select the security settings to match your network settings.



- 3 When you have finished making settings, select **Complete** and follow the on-screen instructions to save your settings and exit the menus.

Projecting in Epson iProjection (iOS/Android)

You can display a QR code on the screen and project data easily from a smartphone or tablet using the Epson iProjection app (version 3.1.1 or later).



- You can download Epson iProjection for free from the App Store or from Google Play. Any fees incurred when communicating with the App Store or Google Play are the responsibility of the customer.
- When using Epson iProjection in **Quick** connection mode, we recommend making security settings.
👉 [p.54](#)

- 1 Press the [Menu] button to display menus in the order **Network - Wireless LAN Power**.

- 2 Use the up and down buttons to select **On**, and then press the [Enter].

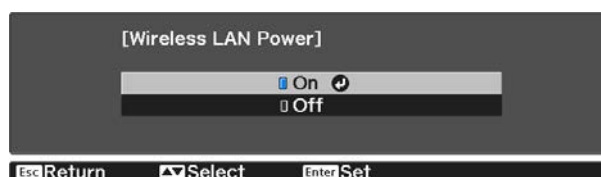

- 3 Display the **Network Configuration - Basic - Display LAN Info** menu.

4 Use the up and down buttons to select **Text & QR Code**, and then press the [Enter] button.

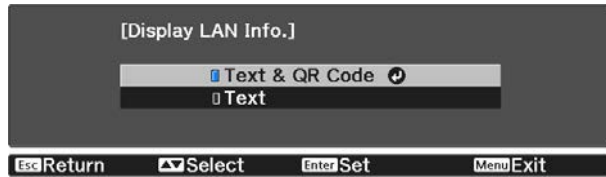

5 Press the [LAN] button on the remote control or select **Display the QR Code** in the projector's **Network** menu to display the QR code.

- If you press the [Home] button, you can also display the QR code from the Connection Guide on the Home screen. [p.26](#)
- If the projector is already receiving an image signal over the network, the QR code is not displayed even if you press the [LAN] button. Select **Display the QR Code** from the **Network** menu to display the QR code.
- To hide the QR code, press the [Esc] button.

6 Start Epson iProjection on your smartphone or tablet.

7 Read the projected QR code on your smartphone or tablet.

Read the code from in front of the screen so that the QR code fits into the guide. If you are too far from the screen, the code may not be read.

Once connected, go to  and select the **Contents** menu, and then select a file you want to project.

■ Operating using a smartphone (remote control function)

By using Epson iProjection, you can operate the projector from a smartphone or tablet.









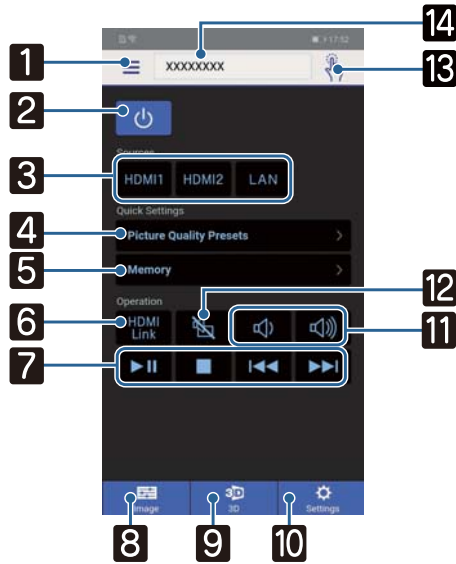



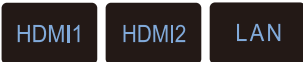

Tap  in Epson iProjection to display the menu.



Tap **Remote control** on the menu to display the following screen.



When Remote Password is set, you need to enter the password. Once the password has been recognized, you do not need to enter it from the second time.



	Button	Function
1		Displays the menu.
2		Turns the projector on or off.
3		Changes to the image from each input port.  p.26
4		Sets the image quality using the on-screen instructions.
5		Saves, loads, erases, or rename a memory.  p.44
6		Turns HDMI Link on or off.  p.49
7		When HDMI Link is On, you can perform operations such as Play, Stop, Fast Forward, Rewind, Next Chapter, Previous Chapter, and Pause.
8		Specify Color Mode , White Balance , Image Enhancement , Gamma , RGBCMY , Power Consumption , Auto Iris , Frame Interpolation , and Image Processing .
9		Specify 3D Display , 3D Format , 3D Depth , Diagonal Screen Size , and 3D Brightness .
10		Specify Aspect , Keystone , Bluetooth , Reset All Config , Reset Memory , and Test Pattern .
11		When HDMI Link is set to On, you can adjust the volume.

Button		Function
12		When HDMI Link is set to On, you can turn the image and audio on/off temporarily. p.33
13		Opens the touch pad screen. You can operate the projector's menu screens by touching your touch pad.
14	<input type="text" value="XXXXXXX"/> 	Selects the projector you want to control.

Configuration Menu Functions

Configuration Menu Operations

On the Configuration menu, you can make adjustments and settings for Signal, Image, Input Signal, and so on.

1 Press the [Menu] button.

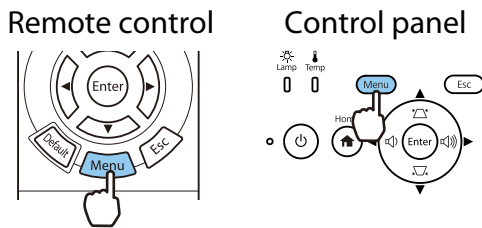

The Configuration menu is displayed.

2 Use the up and down buttons to select the top menu on the left, and then press the [Enter] button to confirm the selection.

When you select the top menu on the left, the sub menu on the right changes.

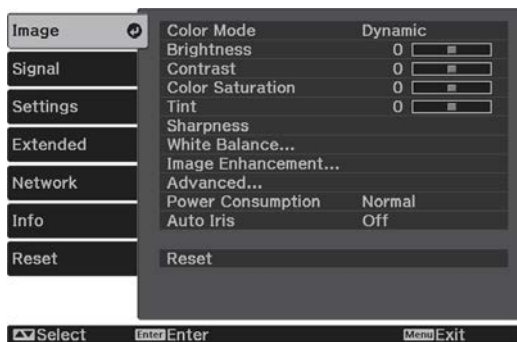

The line at the bottom is a guide for operations.

3 Use the up and down buttons to select the sub menu on the right, and then press the [Enter] button to confirm the selection.

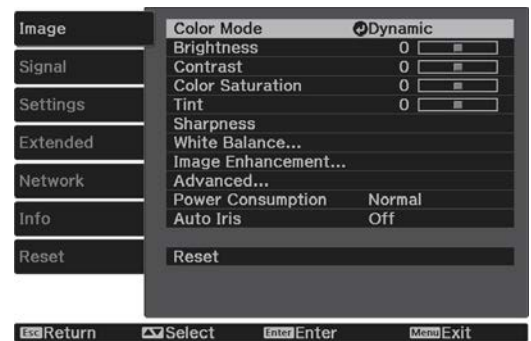

The adjustment screen for the selected function is displayed.

4 Use the up/down/left/right buttons to adjust the settings.

Ex.) Adjustment bar



Ex.) Choices

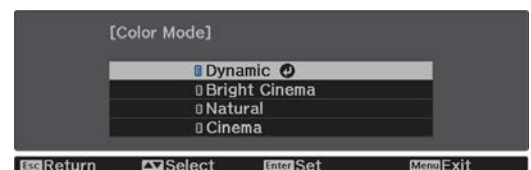

Press the [Enter] button on an item displaying this icon to change to the selection screen for that item.

Press the [Esc] button to return to the previous level.

5 Press the [Menu] button to exit the menu.









For items adjusted using an adjustment bar such as the Brightness, you can press the [Default] button while the adjustment screen is displayed to return the adjustment value to its default value.

Configuration Menu Table

If there is no image signal being input, you cannot adjust items related to the **Image** or **Signal** in the Configuration menu. Note that the items displayed for the **Image**, **Signal**, and **Info** vary depending on the image signal being projected.

Image menu

Function	Menu/Settings		Explanation
Color Mode	Dynamic, Bright Cinema, Natural, Cinema		Select a color mode based on your surroundings and the image you are projecting. p.34
Brightness			Adjusts the brightness when the image appears too dark.
Contrast			Adjusts the contrast between light and shade in the images. By increasing the contrast, the images become vivid.
Color Saturation			Adjusts the color saturation for the images.
Tint			Adjusts the tint for the images.
Sharpness			Adjusts the image sharpness.
White Balance	Color Temp.		Adjusts the tint for the images. The image is tinted blue for high values, and tinted red for low values.
	G-M Correction		The image becomes greener when set to a positive value and redder when set to a negative value.
	Custom		Adjusts the offset and gain for each R, G, and B color.
	Grayscale	Adjustment Level, Red, Green, Blue, Brightness	Adjusts red, green, blue, and brightness for the selected adjustment level.

Function	Menu/Settings		Explanation
Image Enhancement*1	4K Enhancement	On, Off	You can project at a doubled resolution.
	Image Preset Mode	Off, Preset 1 to Preset 5	Select the settings prepared in advance as the settings for Frame Interpolation , Deinterlacing , Noise Reduction , MPEG Noise Reduction , Super-resolution , and Detail Enhancement .
	Frame Interpolation	Off, Low, Normal, High	Adjusts the smoothness of movement of the image.
	Deinterlacing	Off, Video, Film/Auto	(This can only be set when Image Processing is set to Fine or when receiving 480i, 576i, or 1080i signal input from the HDMI1 or HDMI2 ports.) Converts the signal from interlaced (i) to progressive (p) using a method appropriate for the image signal. <ul style="list-style-type: none"> • Off: This is ideal for dynamic motion images. • Video: This is ideal for viewing general video images. • Film/Auto: Performs the optimal conversion for film, CG, or animation input signals.
	Noise Reduction		Adjusts the roughness of the image.
	MPEG Noise Reduction		Smooths out rough images in MPEG format.
	Super-resolution	Fine Line Adjust, Soft Focus Detail	Adjusts the amount of enhancement for complicated images and backgrounds.
	Detail Enhancement	Strength, Range	Creates a more emphatic texture and material feel of the image.
Advanced	Gamma	2, 1, 0, -1, -2, Custom*2, Reset	Performs gamma adjustments. You can select a raw value or adjust using a custom value.  p.42
	RGBCMY	R/G/B/C/M/Y	Hue, Saturation, Brightness  Adjusts the Hue, Saturation, and Brightness for each R, G, B, C, M, and Y color.  p.41
Power Consumption	High, Medium, ECO		You can set the lamp brightness to one of three settings. Select ECO if the images being projected are too bright. When ECO is selected, power consumption during projection decreases, and fan rotation noise is reduced.
Auto Iris	Off, Normal, High Speed		You can change the luminance adjustment tracking for changes in brightness in the displayed image.  p.38
Reset	Yes, No		Resets the adjustment values of Image set in the current Color Mode to the default settings.

*1 Only when an HDMI1 or HDMI2 image signal is being input.

*2 Settings are saved for each type of input source or Color Mode.

■ Signal menu

The Signal menu cannot be set when a LAN image signal is being input.

Function	Menu/Settings		Explanation
3D Setup	3D Display	Auto, 3D, 2D	To view 3D images, set this to Auto or 3D . 👁 p.46
	3D Format	Side by Side, Top and Bottom	Sets the 3D format for the input signal.
	3D Depth	-10 to 10	Sets the depth for the 3D image.
	Diagonal Screen Size	60 to 300	Sets the projection size for the 3D image. By matching this to the actual size, you can achieve the optimum 3D effect.
	3D Brightness	Low, Medium, High	Sets the brightness for the 3D image.
	Inverse 3D Glasses		Reverses the synchronization timing for the left/right shutters on the 3D Glasses and the left/right images. Enable this function if the 3D effect is not displayed correctly.
	3D Viewing Notice	On, Off	Turns the notice that appears when viewing 3D content on or off.
Aspect*1	Auto*2, Normal, Full, Zoom, Anamorphic Wide*3, Horiz. Squeeze*3		Selects the aspect mode. 👁 p.34
Overscan*1	Auto, Off, 4%, and 8%		Changes the output image ratio (the range of the projected image). <ul style="list-style-type: none"> • Off, 4%, 8%: Sets the range of the image. When set to Off, the entire range of the image is projected. Depending on the image signal, you may notice noise at the top and bottom of the image. • Auto: Automatically sets to Off or 8% depending on the input signal.
Color Space	Auto, BT.709, BT.2020		Sets the conversion system for the color space.
Dynamic Range	Dynamic Range	Auto, SDR, HDR10, HLG	Lets you change the range of dark and bright areas in images.
	Signal Status	-	Displays the image signal.
	HDR10 Setting	1 to 16	Lets you change the PQ curve of the dynamic range in the HDR PQ method.
	HLG Setting	1 to 16	Lets you change the HLG curve of the dynamic range in the HDR HLG method.





Function	Menu/Settings		Explanation
Advanced	Video Range* ¹	Auto, Limited (16-235), Full (0-255)	When set to Auto , the video level for the DVD input signal to the HDMI1 or HDMI2 ports is automatically detected and set. If you experience under or overexposure when set to Auto , set the video level of the projector to match that of the DVD/Blu-ray disc player's video level. Your player may be set to Normal (Limited) or Expand (Full).
	EDID	Normal, Expanded	Lets you change the EDID settings. Normal supports 3840 x 2160 30Hz signals, and Expanded supports 3840 x 2160 60 Hz signals.
	Image Processing	Fine, Fast	Improves the response speed for images projected at high-speed, such as games.
Reset	Yes, No		Resets all Signal settings except for Diagonal Screen Size , 3D Viewing Notice , and Aspect .

*1 Settings are saved for each type of input source or signal.

*2 You may not be able to make selections depending on the source or type of signal.

*3 EH-TW7100 only.

 Settings menu



Function	Menu/Settings		Explanation
Keystone	H/V-Keystone	V-Keystone -60 to 60	Corrects keystone distortion.  p.30 <ul style="list-style-type: none"> • H/V-Keystone: Manually corrects horizontal and vertical distortions.  p.31 • Quick Corner: Corrects the corners of the projected image individually.  p.32
		H-Keystone -60 to 60	
	Quick Corner	-	
Blanking			Covers part of the image with a blank (black screen). You can set the top, bottom, left, or right of the image.
Audio	Volume		Adjusts the volume.
	Inverse Audio*	On, Off	Sets whether or not to invert the left and right audio output channels. Set to On when the projector is suspended from a ceiling and is using the internal speakers.

Function	Menu/Settings		Explanation
HDMI Link	Device Connections	-	Displays a list of devices connected from the HDMI1 or HDMI2 ports.
	HDMI Link	On, Off	Enables or disables the HDMI Link function.
	Audio Out Device	Projector, AV System	Selects which device outputs audio.  p.49
	Power On Link	Off, Bidirectional, Device -> PJ, PJ -> Device	<p>Sets the link function when the power is turned on.</p> <ul style="list-style-type: none"> • When linking operations to the connected device and turning on the projector, select Bidirectional or Device -> PJ. • When linking power on for the projector to the connected device, select Bidirectional or PJ -> Device.
	Power Off Link	On, Off	Sets whether or not to power off connected devices when the projector is turned off.
	Link Buffer	On, Off	If HDMI Link is not working correctly, you may be able to improve it by changing the settings.
Bluetooth	Search Bluetooth Device	-	Searches for available Bluetooth devices and displays them as a list.
	Bluetooth Audio	On, Off	<p>Enables or disables audio output from Bluetooth audio devices.</p> <p>Setup cannot be performed in the following cases.</p> <ul style="list-style-type: none"> • When the source is LAN or USB • When Audio Out Device from the HDMI Link menu is set to AV System
	Connected Device	-	Displays information on the connected Bluetooth audio device.

Function	Menu/Settings		Explanation
Lock Setting	Child Lock	On, Off	<p>This locks the standby button on the projector's control panel to prevent children from turning on the projector by accident. You can turn on the power when locked by holding down the standby button for approximately three seconds. You can still turn off the device using the standby button or perform operations with the remote control as usual.</p> <p>If changed, this setting is enabled after you power off the projector and the cool-down process is complete.</p> <p>Note that even if Child Lock is set to On, the projector still turns on when the power cord is connected if Direct Power On is set to On.</p>
	Control Panel Lock	Full Lock, Partial Lock, Off	<p>Full Lock: Disables all of the projector's buttons. Partial Lock: Disables all of the projector's buttons except for the standby button.</p> <p> is displayed on the screen if buttons are pressed while the projector is locked. To unlock, press and hold the standby button on the control panel for at least 7 seconds.</p> <p>If changed, this setting is enabled once you close the Configuration menu.</p>
User Button	3D Display, Power Consumption, Info		Select a Configuration menu item to assign to the [User] button on the remote control. By pressing the [User] button, the assigned menu item selection/adjustment screen is displayed, allowing you to make one-touch settings/adjustments.
Memory	Load Memory	Memory1 to Memory10	Loads the settings saved in Save Memory to adjust the image.
	Save Memory	Memory1 to Memory10	Saves the settings made in Image to a memory.
	Erase Memory	Memory1 to Memory10	Erases a saved memory.
	Rename Memory	Memory1 to Memory10, Default, DVD, VCR, SDTV, HDTV, Cinema, Sports, Music, Anime, Game, Custom	Changes the saved memory name.
Reset	Yes, No		Resets all Settings except for Inverse Audio, Audio Out Device, Power On Link, Power Off Link, Link Buffer, User Button, and Memory .

* EH-TW7100 only.

Extended menu

Function	Menu/Settings		Explanation	
Home Screen	Home Screen Auto Disp.	On, Off	Selects whether or not to display the Home screen automatically when the projector turns On . The Home screen is not displayed when the selected source has an image signal when the projector turns on.	
	Custom Function 1	Power Consumption, Auto Iris, Keystone, Info	Select the function assigned to the Home screen.	
	Custom Function 2			
Display	Messages	On, Off	<p>Sets whether or not to display the following messages (On or Off).</p> <ul style="list-style-type: none"> Item names for image signals, color modes, and aspect ratios. If the internal temperature is rising when no image signal is being input or an unsupported signal is detected. 	
	Display Background	Black, Blue, Logo	Selects the screen status when no image signal is being input.	
	Startup Screen	On, Off	Sets whether or not to show a startup screen when projection begins (On or Off). If changed, this setting is enabled after you power off the projector and the cool-down process is complete.	
	Standby Confirmation	On, Off	Sets whether or not to display a standby confirmation message (On or Off).  p.27	
	Panel Alignment	-	 p.67	
	Color Uniformity	Color Uniformity	On, Off	Enables or disables Color Uniformity.
		Adjustment Level		There are eight levels from white, through gray, and up to black. You can adjust each level individually.
		Start Adjustments	Red, Green, Blue	Starts making Color Uniformity adjustments.
		Reset	Yes, No	Resets all adjustments and settings for Color Uniformity to their default values.
	Projection	Front, Front/Ceiling, Rear, Rear/Ceiling		Change this setting depending on how the projector is installed.

Function	Menu/Settings		Explanation
Operation	Direct Power On	On, Off	You can set up the projector so that projection starts as soon as the power cord is plugged in without any button operations. Note that when this is set to On , projection starts if power is restored after a blackout or other power outage and the power cord is still plugged into the projector.
	Sleep Mode	On, Off	If the set time is exceeded and no signal is input, the projector is automatically turned off and enters standby mode. When in standby mode, press the power button on the remote control or the standby button on the control panel to re-start projection.
	Sleep Mode Timer	1 to 30 mins.	Sets the interval for Sleep Mode .
	Illumination	On, Off	Set this to Off if the light from the indicators on the control panel bother you when watching a movie in a dark room.
	Trigger Out*	Off, Power, Anamorphic Wide	Set the Trigger Out function to communicate the projector's power on status and so on to external devices. When set to Off , no voltage is output from the Trigger Out port. When set to Power , voltage is output from the Trigger Out port when the projector is on. For Anamorphic Wide , when the projector is on and Aspect is set to Anamorphic Wide or Horiz. Squeeze , voltage is output from the Trigger Out port. If you change this setting, the new setting will take effect the next time you turn the projector on.
	High Altitude Mode	On, Off	Set this to On if you are using the projector above an altitude of 1500 meters.
	Log Save Destination	Internal Memory, USB and Internal Memory	Set where you want to save the logs.
Standby Mode	Communication Off, Communication On		Communication On indicates that the projector can be monitored over a network when the projector is in standby mode.
Language	-		Selects the display language.
Reset	Yes, No		Resets all Extended settings except for Memory, Projection, High Altitude Mode, Standby Mode, and Language .

* EH-TW7100 only.

Panel Alignment menu

Menu/Settings			Explanation	
Panel Alignment	Panel Alignment	On, Off	Enables or disables Panel Alignment.	
	Select Color	R, B	Select the color to correct.	
	Pattern Color	R/G/B, R/G, G/B	Select the pattern used for correction.	
	Start Adjustments	-	Starts Panel Alignment.  p.90	
	Memory	Load Panel Alignment	Memory1, Memory2, Memory3	Loads settings saved using the Save Panel Alignment function.
		Save Panel Alignment	Memory1, Memory2, Memory3	Saves the settings made in Panel Alignment to a memory.
		Erase Panel Alignment	Memory1, Memory2, Memory3	Erases memories registered using the Panel Alignment function.
		Rename Panel Alignment	Memory1, Memory2, Memory3	Renames Panel Alignment memories.
Reset	Yes, No	Resets the correction value.		

 Network menu

Function	Menu/Settings	Explanation
Wireless LAN Power	On, Off	Sets whether or not (On or Off) to use Wireless LAN Power.
Net. Info. - Wireless LAN	-	Displays the following network settings. <ul style="list-style-type: none"> • Connection Mode • Wireless LAN system • Antenna Level • Projector Name • SSID • DHCP • IP Address • Subnet Mask • Gateway Address • MAC Address • Region Code
Display the QR Code	-	Displays network information for the projector with a QR code.
Network Configuration	-	Displays the screen to set the network.  p.68

Notes on operating the Network menu

Basic operations are made in the same way as when using the Configuration menu. However, be sure to select the **Complete** menu to save your settings when done.



- Yes:** Saves the settings and exits the Network menu.
- No:** Exits the Network menu without saving the settings.
- Cancel:** Continues displaying the Network menu.

Soft keyboard operations

In the Network menu, the soft keyboard appears when you need to enter numbers and characters. Use the up/down/left/right buttons on the remote control or control panel to select keys, and then press the [Enter] button to input the text. Press **Finish** to confirm your input, or **Cancel** to cancel your input.





- CAPS key:** Switches between uppercase and lowercase letters.
- SYM1/2 key:** Switches the symbol keys.

Basic menu

Function	Menu/Settings	Explanation
Projector Name	Up to 16 alphanumeric characters	Enter a name to identify the projector over a network.
Remote Password	Up to 8 alphanumeric characters	Set a password to use when you operate the projector from a smartphone or a tablet.
Display LAN Info.	Text & QR Code, Text	Set the display format for the projector's network information.

Wireless LAN menu

Function	Menu/Settings	Explanation
Connection Mode	Quick, Advanced	Determines how the wireless LAN is connected. Quick: Using Epson iProjection allows you to connect to smartphones, tablets, or computers directly using wireless communication. The projector becomes a simple access point. (Make sure the number of devices connected to the projector is six or less. It may take longer to update the projected image if the number of connected devices exceeds this number.) Advanced: Lets you connect to multiple smartphones, tablets, or computers over a wireless network access point.
Channel*1	1ch, 6ch, 11ch	Select the frequency bandwidth used by the wireless LAN.
SSID*2	Up to 32 alphanumeric characters	Enter an SSID. When an SSID is provided for the wireless LAN system in which the projector participates, enter the SSID.
Search Access Point*2	To Search View	Search for available wireless network access points.  indicates currently connected access points.  indicates access points where security is set. If you select an access point that has security enabled, Security menu appears.  p.69
IP Settings*2	DHCP	Set whether or not (On/Off) to use DHCP. If this is set to On , you cannot set any more addresses.
	IP Address	Inputs the IP address for the projector. The following IP addresses cannot be used. 0.0.0.0, 127.x.x.x, 224.0.0.0 to 255.255.255.255 (where x is a number from 0 to 255)
	Subnet Mask	Enter the projector's subnet mask. The following subnet masks cannot be used. 0.0.0.0, 255.255.255.255
	Gateway Address	Enter the projector's gateway IP address. The following gateway addresses cannot be used. 0.0.0.0, 127.x.x.x, 224.0.0.0 to 255.255.255.255 (where x is a number from 0 to 255)
SSID Display	On, Off	Sets whether or not to display the SSID on the LAN Standby screen and the Home screen (On or Off).
IP Address Display	On, Off	Sets whether or not to display the IP address on the LAN Standby screen and the Home screen (On or Off).

*1 This can only be set when **Connection Mode** is set to **Quick**.

*2 This can only be set when **Connection Mode** is set to **Advanced**.

Security menu

Function	Menu/Settings	Explanation
Security	No, WPA2-PSK, WPA/WPA2-PSK	Sets the security. In Quick , WPA2-PSK is selectable. In Advanced , WPA2-PSK/WPA/WPA2-PSK is selectable.
Passphrase	From 8 to 32 single-byte alphanumeric characters	Inputs the passphrase. It is recommended to change the passphrase periodically for the purpose of security.

Reset menu

Function	Explanation
Reset network settings.	You can reset all adjustment values for Network to their default settings.

■ Info menu

Function	Menu/Settings	Explanation
Projector Info	Lamp Hours	Displays the cumulative lamp operating time.
	Source	Displays the current input source.
	Input Signal*	Displays the input signal setting of the current input source.
	Resolution*	Displays the resolution.
	Scan Mode*	Displays the scan mode.
	Refresh Rate*	Displays the refresh rate.
	3D Format*	Displays the 3D format of the signal input during 3D projection (Frame Packing, Side by Side, or Top and Bottom).
	Sync Info*	Displays the image signal information. This information may be needed if service is required.
	Color Depth*	Displays the color depth and color difference.
	Color Format*	Displays information on the Color Space and Dynamic Range.
	Status	This is information about errors that have occurred on the projector. This information may be needed if service is required.
	Serial Number	Displays the projector's serial number.
Event ID	The application error log appears. 🖨️ p.82	
Version	Main	Displays the firmware version of the projector.
	Video2	

*This is not displayed when a LAN image signal is being input.

■ Reset menu

Function	Explanation
Reset Lamp Hours	Resets the cumulative lamp hours use time to 0 H. Reset when you replace the lamp.
Reset Memory	Resets all items for Memory to their default settings.
Reset All Config	Resets all items in the Configuration menu to their default settings. The following adjustment values are not reset to their defaults: Memory, Panel Alignment, Color Uniformity, Lamp Hours, Language, and Network Settings.

Problem Solving

Reading the Indicators

You can check the status of the projector from the flashing and lit status indicator, standby indicator, lamp indicator, and temperature indicator on the control panel.

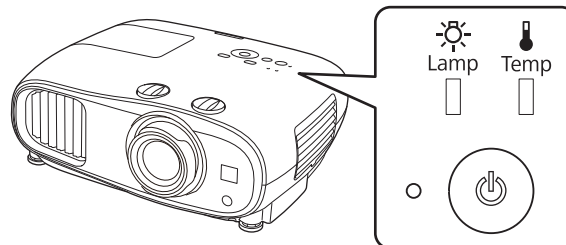









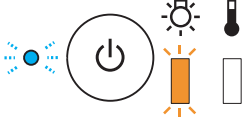

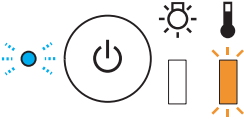
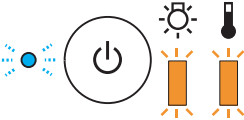
Refer to the following table to check the projector's status and how to remedy problems shown by the indicators.

Indicator status during an error/warning

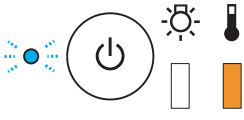

■ : Lit ■ (with dots) : Flashing ■ (with vertical lines) : Status dependent □ : Off

Indicators	Status	Remedy
 (blue)/(orange)	Replace Lamp	It is time to replace your lamp. Replace the lamp with a new lamp as soon as possible. p.87 The lamp may explode if you continue to use it in this status.
 (blue)/(orange)	High Temp Warning	You can continue projecting. If the temperature rises too high again, projection stops automatically. <ul style="list-style-type: none"> • If the projector is installed next to a wall, make sure there is at least 20 cm between the wall and the projector's exhaust vent. • If the air filter is clogged, clean it. p.84 • Make sure that nothing is blocking the area around the inlet and that the temperature around the inlet is not too high. p.99

Indicators	Status	Remedy
 <p>(blue)/(orange)</p>	Internal Error	<p>The projector has malfunctioned.</p> <p>Remove the power plug from the electrical outlet, and contact your local dealer or the nearest Epson repair center.  Epson Projector Contact List</p>
 <p>(blue)/(orange)</p>	Fan Error Sensor Error	
 <p>(blue)/(orange)</p>	Auto Iris Error	
 <p>(blue)/(orange)</p>	Power Err. (Ballast)	
 <p>(blue)/(orange)</p>	Lamp Error Lamp Failure	<p>There is a problem with the lamp, or it failed to turn on.</p> <ul style="list-style-type: none"> • Disconnect the power cord, and then check if the lamp is cracked.  p.87 If it is not cracked, reinstall the lamp and turn on the power. If reinstalling the lamp does not fix the problem, or if the lamp is cracked, remove the power plug from the electrical outlet, and contact your local dealer or the nearest Epson repair center.  Epson Projector Contact List • Check that the lamp cover has been properly closed.
 <p>(blue)/(orange)</p>	High Temp Error (Overheating)	<p>The internal temperature is too high.</p> <ul style="list-style-type: none"> • The lamp turns off automatically and projection stops. Wait for about five minutes. When the fan has stopped, disconnect the power cord. • If the projector is installed next to a wall, make sure there is at least 20 cm between the wall and the projector's exhaust vent. • If the air filter is clogged, clean it.  p.84 • Make sure that nothing is blocking the area around the inlet and that the temperature around the inlet is not too high.  p.99 • If turning the power back on does not clear the problem, stop using the projector and remove the power plug from the electrical outlet. Contact your local dealer or the nearest Epson repair center.  Epson Projector Contact List • When using at an altitude of 1500 m or more, set High Altitude Mode to On.  Extended - Operation - High Altitude Mode p.65

Indicator status during normal operation

 : Lit  : Flashing  : Off

Indicators	Status	Remedy
	Standby condition	When you press the power button on the remote control, or the standby button on the control panel, projection starts after a short wait. When Standby Mode is set to Communication On , the standby indicator remains on even when the projector is standing by.
 (blue)	Warm-up in progress	Warm-up time is about 30 seconds. The power-off operation is disabled while the projector is warm-ing-up.
	Cool-down in pro-gress	All operations are disabled while the projector is cooling-down. The projector enters standby condition when cool-down is com-plete. If for any reason the power cord is disconnected during cool-down, wait until the lamp has cooled down sufficiently (about 10 minutes), reconnect the power cord, and then press the power button on the remote control, or the standby button on the control panel.
 (blue)	Projection in pro-gress	The projector is operating normally.



- Under normal operating conditions, the temperature and lamp indicators are off.
- When the **Illumination** function is set to **Off**, all indicators are off under normal projection conditions.
 **Extended - Operation - Illumination** [p.65](#)

When the Indicators Provide No Help

■ Check the problem



Check the following table to see if your problem is mentioned, and go to the appropriate page for information on handling the problem.

Problem	Page	
Problems relating to images	No images appear Projection does not start, the projection area is completely black, or the projection area is completely blue.	p.75
	Moving images being projected from a computer are not projected.	p.75
	"Not supported" is displayed	p.75
	"No Signal" is displayed	p.76
	Keystone distortion of projected image	p.76
	Images are fuzzy or out of focus	p.76
	Interference or distortion appears in the images.	p.76
	The image is truncated (large) or small, or only a part of the image is projected.	p.77
	Image colors are not right The whole image appears purplish or greenish, images are black & white, or colors appear dull.*	p.77
	Images appear dark	p.77
	Projection stops automatically	p.78
	Noise problems	No audio, or the audio is too low p.78
Problems when projection starts	The projector does not turn on p.78	
Problems with the remote control	The remote control does not respond p.79	
Problems with the control panel	Cannot make settings on the control panel p.79	
Problems with 3D	Cannot project correctly in 3D p.79	
Problems with HDMI	HDMI Link does not function p.80	
	The device name is not displayed under Device Connections p.81	
Bluetooth device problems	Cannot Connect Bluetooth Device p.81	
	The audio and connection for the Bluetooth device disconnects p.81	
Network problems	Cannot access the network via wireless LAN p.81	
	The image contains static during network projection p.82	

* Because color reproduction differs between monitors and computer LCD screens, the image projected by the projector and the color tones displayed on the monitor may not match, however this is not a fault.

■ Problems relating to images



No images appear

Check	Remedy
Is the power turned on?	Press the power button on the remote control or the standby button the control panel to turn on the projector.
Is the power cord connected?	Connect the power cord.
Are the indicators switched off?	Disconnect and then reconnect the projector's power cord. Check that pressing the power button after connection supplies the projector with power.
Is an image signal being input?	Check that the connected device is turned on. When Messages is set to On from the Configuration menu, image signal messages are displayed.  Extended - Display - Messages p.65
Has the power to the AV amplifier been disconnected?	If an AV amplifier is connected, check the AV amplifier's power supply.
Is an image signal being sent from the device?	Check that an image signal is being sent from the connected device.
Are the Configuration menu settings correct?	Reset all of the settings.  Reset - Reset All Config p.70
(Only when projecting computer image signals) Was the connection made while the power of the projector or the computer was already turned on?	If the connection is made while the power is already turned on, the Fn key (Function key) that changes the computer's image signal to external output may not work. Turn off the power for the computer and the projector and then turn it back on again.



Moving images are not displayed

Check	Remedy
(Only when projecting computer image signals) Is the computer's image signal set to external output and to output to the LCD monitor at the same time?	Depending on the computer's specifications, moving images may not be displayed when the computer is set to external output and to the LCD monitor output at the same time. Change it so that the image signal is set to external output only. For the computer's specifications, see the documentation supplied with the computer.

"Not supported" is displayed

Check	Remedy
(Only when projecting computer image signals) Do the image signal's frequency and resolution correspond to the mode?	Check the image signal being input in Resolution from the Configuration menu, and check that it corresponds to the projector's resolution.  Info - Projector Info p.70  "Supported Resolutions" p.95



"No Signal" is displayed

Check	Remedy
Are the cables connected correctly?	Check that all the cables required for projection are securely connected.  p.20
Is the correct image input port selected?	Switch the image with the source buttons on the remote control.  p.26
Is the connected device turned on?	Turn on the device.
(Only when projecting computer image signals) Are the image signals being output to the projector?	Change it so that the image signal is set to external output, and not just the computer's LCD monitor. For some models, when the image signals are output externally, they no longer appear on the LCD monitor. For the computer's specifications, see the documentation supplied with the computer. If the connection is made while the power of the projector or the computer is already turned on, the Fn key (Function key) that changes the computer's image signal to external output may not work. Turn the power for the computer and the projector off and then back on again.

Keystone distortion of projected image

Check	Remedy
Is keystone distortion adjusted within the correction range?	If projecting the image from outside of the correctable range, you may not be able to correct the keystone distortion completely. Install the projector horizontally in front of the screen as far as possible, and then adjust the projection position using lens shift.  p.14

Images are fuzzy or out of focus

Check	Remedy
Has the focus been adjusted?	Adjust the focus.  p.28
Is the lens cap attached?	Remove the lens cap.
Is the projector at the correct distance?	Check the recommended projection range.  p.17
Has condensation formed on the lens?	If the projector is suddenly taken from a cold environment to a warm environment, or if sudden ambient temperature changes occur, condensation may form on the surface of the lens, and this may cause the images to appear fuzzy. Set the projector up in the room about one hour before it is used. If the projector is wet from condensation, turn off the projector, disconnect the power cord, and leave it for a while.

Interference or distortion appear in images

Check	Remedy
Are the cables connected correctly?	Check that all the cables required for projection are securely connected.  p.20

Check	Remedy
Is an extension cable being used?	If an extension cable is used, electrical interference may affect the signals.
(Only when projecting computer image signals) Is the correct resolution selected?	Set the computer so that the signals being output are compatible with the projector. 🖱️ p.95

Part of the image is truncated (large) or small

Check	Remedy
Is the correct Aspect selected?	Select the aspect mode to match the input signal in Aspect from the Configuration menu. 🖱️ Signal - Aspect p.61
(Only when projecting computer image signals) Is the correct resolution selected?	Set the computer so that the signals being output are compatible with the projector. 🖱️ p.95

Image colors are not right

Check	Remedy
Are the cables connected correctly?	Check that all the cables required for projection are securely connected. 🖱️ p.20
Is the contrast adjusted correctly?	Adjust the Contrast setting from the Configuration menu. 🖱️ Image - Contrast p.59
Is the color adjusted correctly?	Adjust the Advanced setting from the Configuration menu. 🖱️ Image - Advanced p.59
(Only when projecting images from a video device) Are the color saturation and tint adjusted correctly?	Adjust the Color Saturation and Tint settings from the Configuration menu. 🖱️ Image - Color Saturation/Tint p.59

Images appear dark



Check	Remedy
Is the image brightness set correctly?	Adjust the Brightness setting from the Configuration menu. 🖱️ Image - Brightness p.59
Is the contrast adjusted correctly?	Adjust the Contrast setting from the Configuration menu. 🖱️ Image - Contrast p.59
Is it time to replace the lamp?	When the lamp is nearly ready for replacement, the images become darker and the color quality becomes poorer. When this happens, replace the lamp with a new lamp. 🖱️ p.87

Projection stops automatically

Check	Remedy
Is Sleep Mode enabled?	If the set time is exceeded and no signal is input, the lamp is automatically turned off and the projector enters standby mode. Press the power button on the remote control or the standby button on the control panel to turn on the projector. If you want to disable Sleep Mode , change the setting to Off .  Extended - Operation - Sleep Mode p.65



 Noise problems

No audio, or the audio is too low

Check	Remedy
Is the audio cable connected correctly?	Try disconnecting the cable from the Audio Out port, and then reconnecting.
Is the volume too low?	Adjust the volume so that you can hear the audio.  p.33
Is it connected with an HDMI cable?	If no audio is output when connecting via an HDMI cable, set the connected equipment to PCM output.
Are the Audio Out Device settings correct?	Check that the Audio Out Device settings are correct on the Configuration menu.  Settings - HDMI Link - Audio Out Device p.62
Are the Bluetooth Audio settings correct?	Make the following settings when connecting a Bluetooth audio device. <ul style="list-style-type: none"> To output audio from the projector's speaker or an AV system, set Bluetooth Audio to Off. To output audio from Bluetooth audio devices, set Bluetooth Audio to On.  Settings - Bluetooth - Bluetooth Audio p.62

 Problems when projection starts



The projector does not turn on

Check	Remedy
Is the power turned on?	Press the power button on the remote control or the standby button the control panel to turn on the projector.
Is Child Lock set to On ?	When Child Lock is set to On from the Configuration menu, hold down the standby button on the control panel for approximately three seconds, or perform operations from the remote control.  Settings - Lock Setting - Child Lock p.62
Do the indicators turn on and off when the power cord is touched?	Turn off the projector, and then disconnect and reconnect the projector's power cord. If the problem continues, stop using the projector, remove the power plug from the electrical outlet, and contact your local dealer or the nearest projector information center.  Epson Projector Contact List

Check	Remedy
Are the lamp cover and lamps installed correctly?	If the lamp or lamp cover is installed incorrectly, the projector cannot be turned on. Check how it is installed.  p.87

 Problems with the remote control

The remote control does not respond

Check	Remedy
Is the remote control light-emitting area pointing towards the remote receiver on the projector during operation?	Point the remote control towards the remote receiver. Also, check the operating range.  p.24
Is the remote control too far from the projector?	Check the operating range.  p.24
Is direct sunlight or strong light from fluorescent lamps shining onto the remote receiver?	Set the projector up in a location where strong light does not shine onto the remote receiver.
Are the batteries dead or have the batteries been inserted correctly?	Make sure the batteries are inserted correctly or replace the batteries with new ones if necessary.  p.24

 Problems with the control panel



Cannot make settings on the control panel

Check	Remedy
Is Control Panel Lock set to Full Lock or Partial Lock ?	When Control Panel Lock is set to Full Lock in the Configuration menu, all button operations on the control panel are disabled; when Partial Lock is set, only the standby button on the control panel is available. Perform operations from the remote control.  Settings - Lock Setting - Control Panel Lock p.62

 Problems with 3D



Cannot project correctly in 3D

Check	Remedy
Are the 3D Glasses turned on?	Turn on the 3D Glasses.
Are the 3D Glasses fully charged?	Charge the 3D Glasses.
Is a 3D image being projected?	If the projector is projecting a 2D image, or if an error occurs on the projector that prevents the 3D image from being projected, you cannot view 3D images even if you are wearing the 3D Glasses.
Is the input image in 3D?	Check that the input image is 3D compatible. Since most TV broadcasts do not contain a 3D format signal, 3D reception must be set manually.

Check	Remedy
Is 3D Display set to 2D ?	If 3D Display is set to 2D from the Configuration menu, the projector does not automatically change to 3D even when a 3D image is input. Set 3D Display to either 3D or Auto .  Signal - 3D Setup - 3D Display p.61
Is 3D Format set correctly?	Unless the 3D format of the AV device and 3D Format of the projector are the same, part of the image may not be displayed. Check that the projector's 3D Format setting matches the 3D format setting for the AV device.  Signal - 3D Setup - 3D Format p.61 When changing the 3D Format , set 3D Display to 3D , and then press the [3D Format] button.
Are you viewing within the reception range?	If the distance between the projector and the 3D Glasses exceed 10 m, the connection may be lost. Move the 3D Glasses closer to the projector.
Has pairing been performed correctly?	See the user's guide supplied with your 3D Glasses and perform pairing.
Are there any devices that cause radio wave interference in the vicinity?	When using other devices at the same time with the frequency band (2.4 GHz) such as Bluetooth communication devices, wireless LAN (IEEE802.11b/g), or microwave ovens, radio wave interference may occur, the image may be interrupted, or communication may not be possible. Do not use the projector near these devices.

Problems with HDMI

HDMI Link does not function

Check	Remedy
Are you using a cable that meets the HDMI standards?	Operations are not possible with cables that do not meet the HDMI standards.
Does the connected device meet the HDMI CEC standards?	If the connected device does not meet the HDMI CEC standards, it cannot be operated even if it is connected to the HDMI port. See the documentation and so on supplied with the connected device for more information. Also, press the [HDMI Link] button, and then check if the device is available under Device Connections .  p.50
Are the cables connected correctly?	Check that all the cables required to use HDMI Link are securely connected.  p.49
Is the power for the amplifier or DVD recorder and so on turned on?	Put each device in standby status. See the documentation and so on supplied with the connected device for more information. If you have connected a speaker and so on, set the connected equipment to PCM output.
Was a new device connected, or was the connection changed?	If the CEC function for a connected device needs to be set again, for example when a new device is connected or the connection is changed, you may need to restart the device.
Are many multi-media players connected?	Up to 2 multi-media players that meet the HDMI CEC standards can be connected at the same time.

The device name is not displayed under Device Connections

Check	Remedy
Does the connected device meet the HDMI CEC standards?	If the connected device does not meet the HDMI CEC standards, it is not displayed. See the documentation and so on supplied with the connected device for more information.

Bluetooth device problems

Cannot Connect Bluetooth Device





Check	Remedy
Was a device search performed?	When connecting a Bluetooth device for the first time, or when changing to another Bluetooth device, perform Search Bluetooth Device .  p.21
Does the device support copyright protection (SCMS-T)?	You cannot connect a Bluetooth device that does not support copyright protection (SCMS-T).
Is the device based on A2DP?	You cannot connect a Bluetooth device that does not support A2DP.

The audio and connection for the Bluetooth device disconnects

Check	Remedy
Are there any obstacles between the projector and the Bluetooth device?	Check for any obstacles between the projector and the Bluetooth device, and change their positions to improve communication.
Is the device connected within the specified communication distance?	If the distance between the projector and the Bluetooth device exceed 10 m, the connection may be lost. Move the Bluetooth device closer to the projector.
Are there any wireless equipment or microwave ovens in the vicinity?	If the device is used at the same time as other wireless equipment or microwave ovens, radio wave interference may occur, and the image and audio may be interrupted. Avoid equipment that could cause interference.

Network problems

Cannot access the network via wireless LAN

Check	Remedy
Is Wireless LAN Power set to Off ?	Set Wireless LAN Power to On in the Configuration menu. If this is already set to On , set Wireless LAN Power to Off , and then set it to On again.  Network - Wireless LAN Power p.67
Is the passphrase correct?	Note that the passphrase is case sensitive; upper case and lower case letters are treated as different characters. If you have forgotten your passphrase, set it again.  Network - Network Configuration - Security - Passphrase p.69
Have you checked the Event ID?	Check the Event ID number and perform the following steps.  Info - Projector Info - Event ID p.70  p.82

The settings cannot be modified using the remote controller function for Epson iProjection.

Check	Remedy
Is the connected network device turned on?	When the projector is in the standby mode with Standby Mode set to Communication On , check to see if the connected network device is powered on. After powering on the network device, try starting the projector again.  Extended - Standby Mode p.65

The image contains static during network projection



Check	Remedy
Are there any obstacles between the access point and the connected device?	Check for any obstacles between the access point, the mobile device, the computer, and the projector, and change their positions to improve communication.
Is the distance between the access point and the connected device too far?	Make sure that the access point, the mobile device, the computer, and the projector are not too far apart. Move them closer together and try to connect again.
Are there any Bluetooth devices or microwave oven in the vicinity?	If the wireless connection is slow or your projected image contains noise, check for interference from other equipment, such as a Bluetooth device or microwave. Move the interfering device farther away or expand your wireless bandwidth.
Are too many devices connected?	Reduce the number of connected devices if the connection speed declines.

About Event ID

Check the event ID and perform the remedy given below. If you cannot resolve the problem, contact your local dealer or the nearest Epson repair center.

 [Epson Projector Contact List](#)

Event ID	Cause	Remedy
0022 0027 0028 0029 0030 0031 0035 0434 0481 0482 0485	Network communication is unstable.	Check the network communication status, and reconnect after waiting for a while.
0432 0435	Failed to start the network software.	Restart the projector.
0433	An image that was transferred cannot be reproduced.	Restart the network software.
0484	Communications was cut off from the computer.	

Event ID	Cause	Remedy
04FE	The network software ended unexpectedly.	Check the status of network communications. Wait for a while and then try connecting again.
0479 04FF	A system error occurred in the projector.	Restart the projector.
0891	The same SSID access point cannot be found.	Set the computer, the access point, and the projector to the same SSID.
0892	WPA and WPA2 authentication type mismatch.	Check the setting of wireless LAN security to see if it is correct.
0894	Communications was cut off because a connection was made to the wrong access point.	Check with the network administrator and follow their instructions.
0898	Failed to acquire the DHCP.	Check that the DHCP server is operating correctly. Turn off the DHCP setting if you are not using DHCP.  Network - Network Configuration - Wireless LAN - IP Settings - DHCP p.69
0020 0026 0032 0036 0037 0038 0899	Other connection errors	If restarting the projector or network software does not solve the problem, contact your local dealer or the nearest address provided in the Epson Projector Contact List.  Epson Projector Contact List

Maintenance

Cleaning the Parts

You should clean the projector if it becomes dirty or if the quality of projected images starts to deteriorate.

Warning

Do not use sprays that contain flammable gas to remove dirt and dust from the projector's lens, air filter, and so on. The projector may catch fire due to the high internal temperature of the lamp.

Cleaning the air filter

Clean the air filter if dust has accumulated on the air filter or when the following message is displayed. **"The projector is overheating. Make sure nothing is blocking the air vent, and clean or replace the air filter."**

Attention

- If dust collects on the air filter, it can cause the internal temperature of the projector to rise, and this can lead to problems with operation and shorten the optical engine's service life. It is recommended that you clean the air filter at least once every three months. Clean them more often than this if using the projector in a particularly dusty environment.
- Do not rinse the air filter in water. Do not use detergents or solvents.
- Lightly brush the air filter to clean it. If it is brushed too strongly, dust will be ground into the air filter and cannot be removed.
- Do not use an air duster. Combustible material may remain, and dust may enter the precision parts.

1 Press the standby button on the remote control or the control panel to turn off the power, and then disconnect the power cord.

2 Remove the air filter cover. Hook your finger into the tab on the air filter cover, and remove it downward.

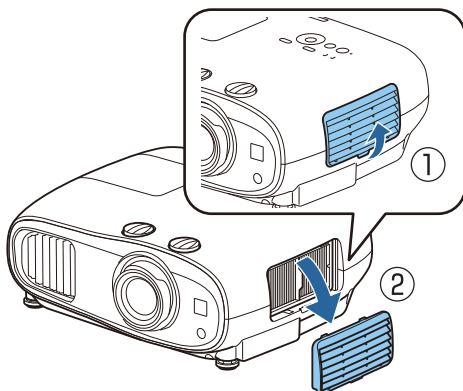

3 Remove the air filter. Grip the knob in the center of the air filter and pull it out.

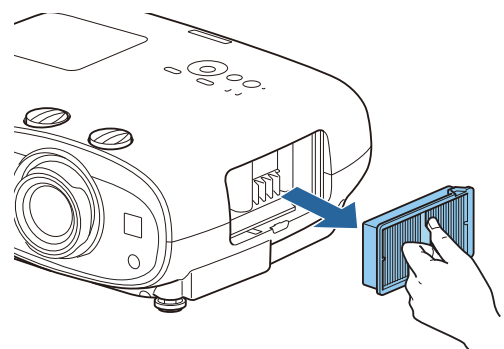

- 4** Hold the air filter with the surface facing down and tap it 4 or 5 times to remove the dust.

Turn it over and tap the other side in the same way.

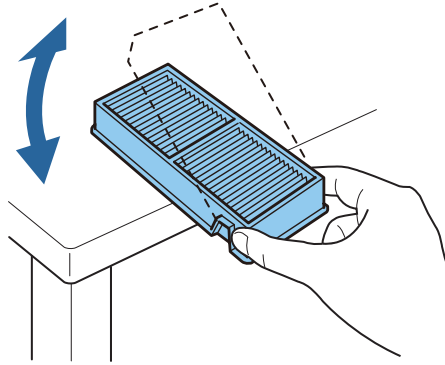

Attention

If the air filter is hit too hard, it may become unusable due to deformities and cracks.

- 5** Remove any dust remaining on the air filter by using a vacuum cleaner from the front side.

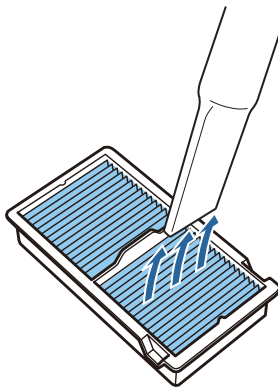

- 6** Install the air filter. Grip the air filter by the knob in the center and insert it straight.

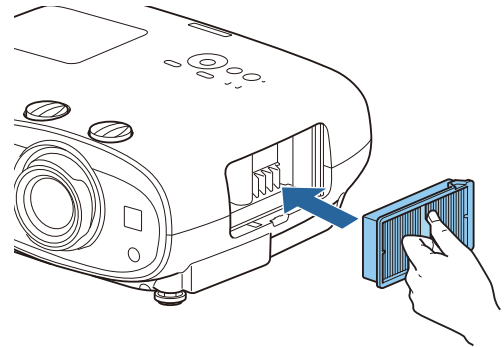

- 7** Install the air filter cover. Fasten the upper catch and then the lower one.

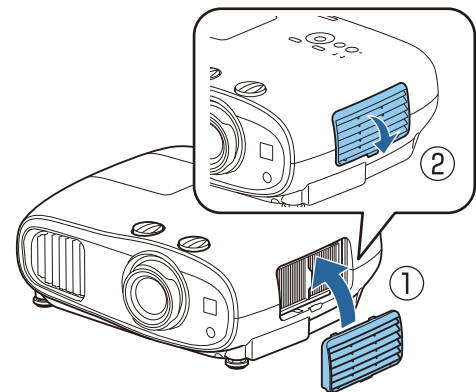

■ Cleaning the main unit

Before cleaning, make sure you unplug the charging adapter from the outlet.

Clean the projector's surface by wiping it gently with a soft cloth.

If it is particularly dirty, use a piece of well-wrung cloth moistened with water and wipe the surface again with a dry cloth.

Attention

Do not use detergent for kitchen or volatile substances such as wax, benzene and thinner to clean the projector's surface. The quality of the outer case may change or the paint may peel off.

■ Cleaning the lens

Clean the projector's lens periodically, or whenever you notice dust or smudges on the surface.

- To remove dust or smudges, gently wipe the lens with clean and dry lenscleaning paper.
- If the lens is dusty, blow off dust using a blower, and then wipe the lens.

Warning

- Before cleaning the lens, turn off the projector and unplug the power cord.
- Do not use any flammable gas sprays such as air dusters to blow off dust. The high heat generated by the projector may cause a fire.

Attention

- Do not wipe the lens right after you turn off the projector. Doing so could damage the lens.
- Do not use any harsh materials to clean the lens and do not subject the lens to any impacts; otherwise, it could be damaged.

Replacement Periods for Consumables

■ Air filter replacement period

If the replacement message is displayed even though the air filter has been cleaned  [p.84](#)

■ Lamp replacement period

- The following message is displayed when projection starts:
"It is time to replace your lamp. Please contact your Epson projector reseller or visit www.epson.com to purchase."
- The projected image gets darker or starts to deteriorate.
- When the lamp replacement message is displayed. The message is displayed when the lamp usage reaches 100 hours before its life expectancy, and disappears after 30 seconds.



- If you continue to use the lamp after the replacement period has passed, the possibility that the lamp may explode increases. When the lamp replacement message is displayed, replace the lamp with a new one as soon as possible, even if it is still working.
- Depending on the characteristics of the lamp and the way it has been used, the lamp may become darker or stop working before the lamp warning message appears. You should always have a spare lamp unit ready in case it is needed.

Replacing Consumables

■ Replacing the air filter



Dispose of used air filters properly in accordance with your local regulations.

- Filter frame: Polypropylene
- Filter: Polypropylene

1 Press the standby button on the remote control or the control panel to turn off the power, and then disconnect the power cord.

2 Remove the air filter cover.
Hook your finger into the tab on the air filter cover, and remove it downward.

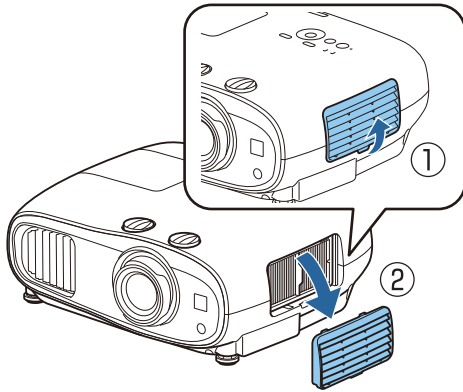

3 Remove the old air filter.
Grip the knob in the center of the air filter and pull it out.

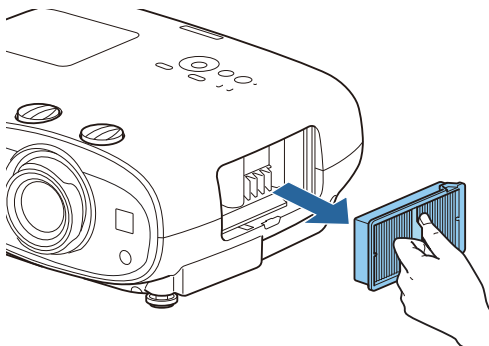

4 Install the new air filter.
Grip the air filter by the knob in the center and insert it straight.

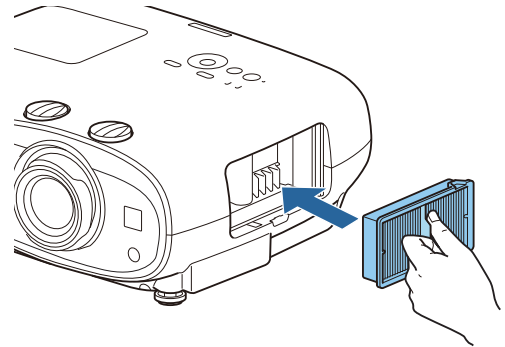

5 Install the air filter cover.
Fasten the upper catch and then the lower one.

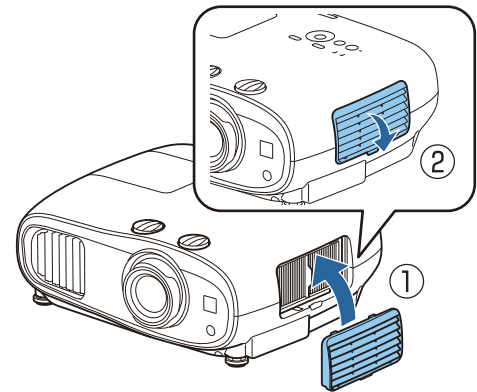

■ Replacing the lamp

Warning

When replacing the lamp because it has stopped illuminating, there is a possibility that the lamp may be broken. If replacing the lamp of a projector that has been suspended from the ceiling, you should always assume that the lamp is cracked, and remove the lamp cover with care. When you open the lamp cover, small shards of glass could fall out. If any shards of glass get into your eyes or mouth, contact a doctor immediately.

 **Caution**

- Do not touch the lamp cover immediately after turning off the projector as it is still hot. Wait until the lamp has cooled down sufficiently before removing the lamp cover. Otherwise, you could get burnt.
- We recommend the use of genuine EPSON option lamps. The use of non-genuine lamps may affect projection quality and safety.
Any damage or malfunction caused by the use of non-genuine lamps may not be covered by Epson's warranty.

1 Press the standby button on the remote control or the control panel to turn off the power, and then disconnect the power cord.

2 Loosen the lamp cover fixing screw.

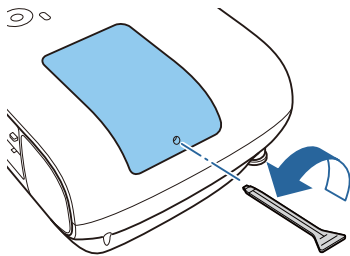

3 Remove the lamp cover.
Slide the lamp cover straight forward and remove it.

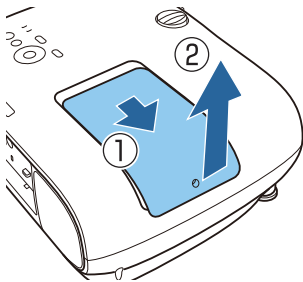

4 Loosen the two lamp fixing screws.

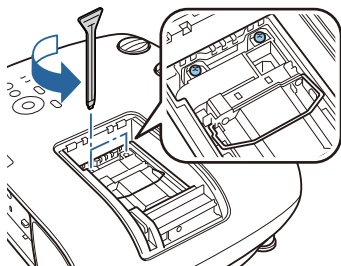

5 Remove the old lamp.
Raise the handle on the lamp, and then pull it straight up.

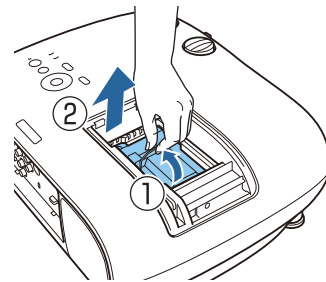

6 Install the new lamp.
Insert the lamp in the correct direction, and then lower the handle.

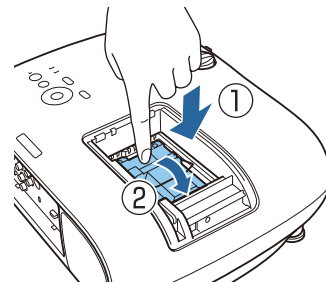

7 Tighten the two lamp fixing screws.

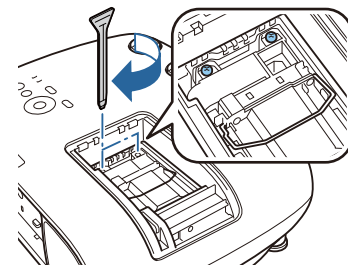

- 8 Replace the lamp cover.
Slide the cover back into place.

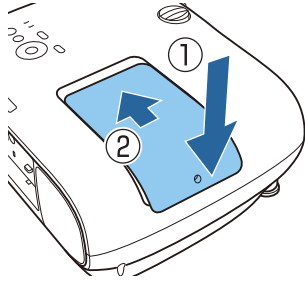

- 9 Tighten the lamp cover fixing screw.

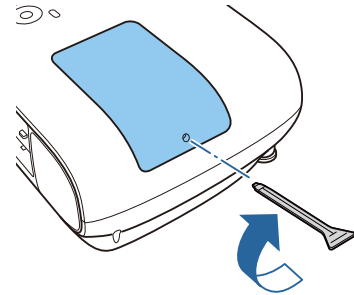

Warning

Do not disassemble or remodel the lamp. If a modified or disassembled lamp is installed in the projector and used, it could cause a fire, electric shock, or an accident.

Caution

- Make sure you install the lamp and lamp cover securely. If they are not installed correctly, the power does not turn on.
- The lamp contains mercury (Hg). Dispose of used lamps in accordance with your local laws and regulations on disposing of fluorescent tubing.

Resetting lamp hours

After replacing the lamp, make sure you reset the lamp hours.

The projector records how long the lamp is turned on and a message and indicator notify you when it is time to replace the lamp.

- 1 Turn on the power.
- 2 Press the [Menu] button.
The Configuration menu is displayed.
- 3 Select **Reset - Reset Lamp Hours**.
A reset confirmation message is displayed.

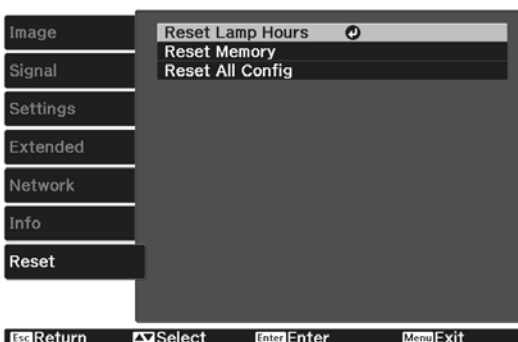

- 4 Use the left and right buttons to select **Yes**, and then press the [Enter] button to execute.

The lamp hours are reset.

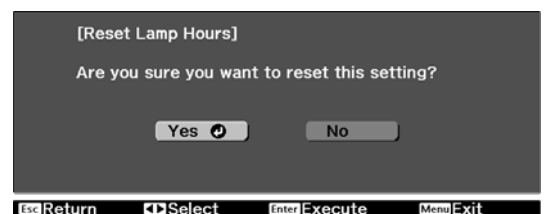

Panel Alignment

Adjusts the pixel color shift of the LCD display. You can adjust the pixels horizontally and vertically by 0.125 pixels within a range of ±3 pixels.



- Image quality may decline after performing LCD alignment.
- Images for pixels that extend beyond the edge of the projected screen are not displayed.

1 Press the [Menu] button while projecting, and then select **Display** from **Extended**.

2 Select **Panel Alignment**, and then press the [Enter] button.

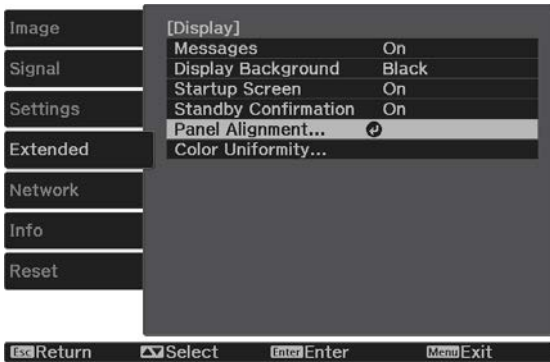

3 Enable **Panel Alignment**.

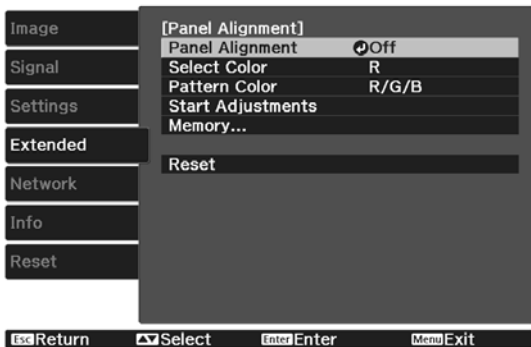

- (1) Select **Panel Alignment**, and then press the [Enter] button.
- (2) Select **On**, and then press the [Enter] button.
- (3) Press the [Esc] button to return to the previous screen.

4 Select the color you want to adjust.

- (1) Select **Select Color**, and then press the [Enter] button.
- (2) Select **R** (red) or **B** (blue), and then press the [Enter] button.
- (3) Press the [Esc] button to return to the previous screen.

5 Select the grid color displayed when making adjustments from **Pattern Color**.

- (1) Select **Pattern Color**, and then press the [Enter] button.
- (2) Select a combination of R (red), G (green), and B (blue) for the grid color.

R/G/B: Displays a combination all three colors; red, green and blue. The actual color of the grid is white.

R/G: This is available when **R** is selected from **Select Color**. Displays a combination of two colors; red and green. The actual color of the grid is yellow.

G/B: This is available when **B** is selected from **Select Color**. Displays a combination of two colors; green and blue. The actual color of the grid is cyan.

- (3) Press the [Esc] button to return to the previous screen.

6 Select **Start Adjustments**, and then press the [Enter] button.

First, select **Shift the whole panel** and adjust the entire LCD display. When a confirmation message is displayed, press the [Enter] button to start the adjustment.

 The image may become distorted while adjusting. The image is restored once adjustments are complete.

7 Use the up/down/left/right buttons to adjust, and then press the [Enter] button.

8 To make more detailed adjustments, select **Adjust the four corners**, and then press the [Enter] button to confirm the selection.

9 Use the up/down/left/right buttons to make adjustments, and then press the [Enter] button to move to the next adjustment point.

10 When you have adjusted all four corners, select **Exit**, and then press the [Enter] button.

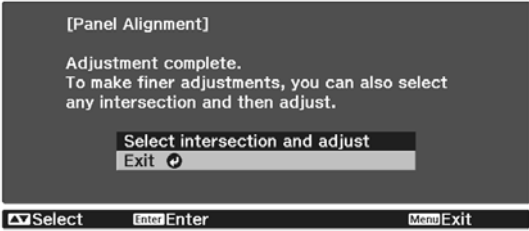

If you feel you still need to make adjustments after correcting all four points, select **Select intersection and adjust** and then continue making adjustments.

Color Uniformity

If colors in the projected image are uneven, you can adjust the color tone of the whole image in **Color Uniformity**.



The color tone may not be uniform even after performing color uniformity.

1 Press the [Menu] button while projecting, and then select **Display** from **Extended**.

2 Select **Color Uniformity**, and then press the [Enter] button.

The following screen is displayed.

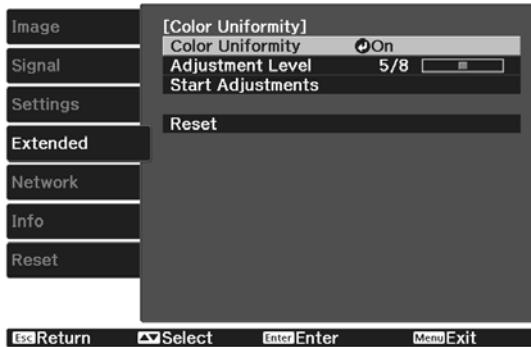

Color Uniformity: Turns color uniformity on or off.

Adjustment Level: There are eight levels from white, through gray, and up to black. You can adjust each level individually.

Start Adjustments: Starts making color uniformity adjustments.

Reset: Resets all adjustments and settings for **Color Uniformity** to their default values.



The image may become distorted while adjusting **Color Uniformity**. The image is restored once adjustments are complete.

3 Select **Color Uniformity**, and then press the [Enter] button.

4 Set this to **On**, and then press the [Esc] button.

5 Select **Adjustment Level**, and then press the [Enter] button.

6 Use the left and right buttons to set the adjustment level.

7 Press the [Esc] button to return to the previous screen.

8 Select **Start Adjustments**, and then press the [Enter] button.

9 Select the area you want to adjust, and then press the [Enter] button.

Adjust the outer areas first, and then adjust the whole screen.

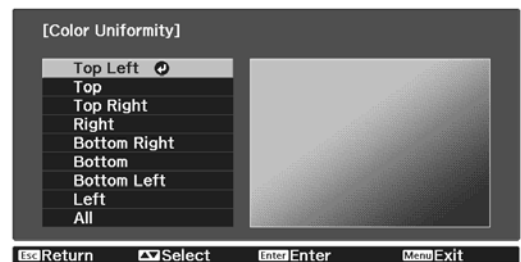

10 Use the up and down buttons to select the color you want to adjust, and then use the left and right buttons to adjust.

Press the left button to weaken the color tone. Press the right button to strengthen the color tone.

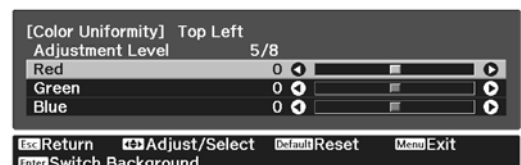

11 Return to step 5 and adjust each level.

12 To complete the adjustment, press the [Menu] button.

Optional Accessories and Consumables

The following optional accessories and consumables are available for purchase if required. This list of optional accessories and consumables is current as of April 2019. Details of accessories are subject to change without notice.

Varies depending on country of purchase.

Optional Items

Name	Model No.	Explanation
Ceiling mount* ¹	ELPMB22 ELPMB30	Use when installing the projector on a ceiling.
Safety wire attachment* ²	ELPWR01	Connects the projector to the ceiling mount.
Ceiling pipe 450 (450 mm white)* ¹	ELPFP13	Use when installing the projector on a high ceiling.
Ceiling pipe 700 (700 mm white)* ¹	ELPFP14	
Wireless LAN unit	ELPAP10	Use when connecting an external device to the projector via a wireless LAN to project images.

*¹ Special expertise is required to suspend the projector from a ceiling. Contact your local dealer.

*² To install the safety wire, contact your local dealer or the nearest projector information center.

Consumables

Name	Model No.	Explanation
Lamp unit	ELPLP85	Use as a replacement for used lamps. (1 lamp)
Air filter	ELPAF39	Use as a replacement for used air filters. (1 air filter)



Supported Resolutions

If the projector receives higher resolution signals than the resolution of the projector panel, the image quality may be degraded.

The projector supports signals marked with a check symbol.

PC

Signal Format	Resolution (Dots)		V Sync (Hz)	Dotclk (MHz)	HDMI								
					RGB		YCbCr						
							4:4:4		4:2:2		4:2:0		
					8	10, 12	8	10, 12	8	10, 12	8	10, 12	
VGA60	640	480	60	25.175	✓								

SD

Signal Format	Resolution (Dots)		V Sync (Hz)	Dotclk (MHz)	HDMI							
					RGB		YCbCr					
							4:4:4		4:2:2		4:2:0	
					8	10, 12	8	10, 12	8	10, 12	8	10, 12
SDTV (480i)	720	480	59.94	13.500	✓	✓	✓	✓	✓	✓		
SDTV (576i)	720	576	50	13.500	✓	✓	✓	✓	✓	✓		
SDTV (480p)	720	480	59.94	27.000	✓	✓	✓	✓	✓	✓		
SDTV (576p)	720	576	50	27.000	✓	✓	✓	✓	✓	✓		

HD

Signal Format	Resolution (Dots)		V Sync (Hz)	Dotclk (MHz)	HDMI							
					RGB		YCbCr					
							4:4:4		4:2:2		4:2:0	
					8	10, 12	8	10, 12	8	10, 12	8	10, 12
HDTV (720p)	1280	720	50	74.250	✓	✓	✓	✓	✓	✓		
HDTV (720p)	1280	720	59.94	74.176	✓	✓	✓	✓	✓	✓		
HDTV (720p)	1280	720	60	74.250	✓	✓	✓	✓	✓	✓		
HDTV (1080i)	1920	1080	50	74.250	✓	✓	✓	✓	✓	✓		
HDTV (1080i)	1920	1080	59.94	74.176	✓	✓	✓	✓	✓	✓		
HDTV (1080i)	1920	1080	60	74.250	✓	✓	✓	✓	✓	✓		
HDTV (1080p)	1920	1080	23.98	74.176	✓	✓*	✓	✓*	✓	✓*		
HDTV (1080p)	1920	1080	24	74.250	✓	✓*	✓	✓*	✓	✓*		

Signal Format	Resolution (Dots)		V Sync (Hz)	Dotclk (MHz)	HDMI							
					RGB		YCbCr					
							4:4:4		4:2:2		4:2:0	
					8	10, 12	8	10, 12	8	10, 12	8	10, 12
HDTV (1080p)	1920	1080	29.97	74.176	✓	✓ *	✓	✓ *	✓	✓ *		
HDTV (1080p)	1920	1080	30	74.250	✓	✓ *	✓	✓ *	✓	✓ *		
HDTV (1080p)	1920	1080	50	148.500	✓	✓ *	✓	✓ *	✓	✓ *		
HDTV (1080p)	1920	1080	59.94	148.352	✓	✓ *	✓	✓ *	✓	✓ *		
HDTV (1080p)	1920	1080	60	148.500	✓	✓ *	✓	✓ *	✓	✓ *		

* HDR is supported. (For HDR, HDR10 and HLG are supported.)

4K

Signal Format	Resolution (Dots)		V Sync (Hz)	Dotclk (MHz)	HDMI							
					RGB		YCbCr					
							4:4:4		4:2:2		4:2:0	
					8	10, 12	8	10, 12	8	10, 12	8	10, 12
4K (3840x2160)	3840	2160	23.98	296.703	✓	✓ *	✓	✓ *	✓	✓ *		
4K (3840x2160)	3840	2160	24	297.000	✓	✓ *	✓	✓ *	✓	✓ *		
4K (3840x2160)	3840	2160	25	297.000	✓	✓ *	✓	✓ *	✓	✓ *		
4K (3840x2160)	3840	2160	29.97	296.703	✓	✓ *	✓	✓ *	✓	✓ *		
4K (3840x2160)	3840	2160	30	297.000	✓	✓ *	✓	✓ *	✓	✓ *		
4K (3840x2160)	3840	2160	50	297.000							✓	✓ *
4K (3840x2160)	3840	2160	59.94	296.703							✓	✓ *
4K (3840x2160)	3840	2160	60	297.000							✓	✓ *
4K (3840x2160)	3840	2160	50	594.000	✓		✓		✓	✓ *		
4K (3840x2160)	3840	2160	59.94	593.407	✓		✓		✓	✓ *		
4K (3840x2160)	3840	2160	60	594.000	✓		✓		✓	✓ *		
4K(4096x2160) (SMPTE)	4096	2160	23.98	296.703	✓	✓ *	✓	✓ *	✓	✓ *		
4K(4096x2160) (SMPTE)	4096	2160	24	297.000	✓	✓ *	✓	✓ *	✓	✓ *		

Signal Format	Resolution (Dots)		V Sync (Hz)	Dotclk (MHz)	HDMI							
					RGB		YCbCr					
							4:4:4		4:2:2		4:2:0	
					8	10, 12	8	10, 12	8	10, 12	8	10, 12
4K(4096x2160) (SMPTE)	4096	2160	25	297.000	✓	✓ *	✓	✓ *	✓	✓ *		
4K(4096x2160) (SMPTE)	4096	2160	29.97	296.703	✓	✓ *	✓	✓ *	✓	✓ *		
4K(4096x2160) (SMPTE)	4096	2160	30	297.000	✓	✓ *	✓	✓ *	✓	✓ *		
4K(4096x2160) (SMPTE)	4096	2160	50	297.000							✓	✓ *
4K(4096x2160) (SMPTE)	4096	2160	59.94	296.703							✓	✓ *
4K(4096x2160) (SMPTE)	4096	2160	60	297.000							✓	✓ *
4K (3840x2160)	4096	2160	50	594.000	✓		✓		✓	✓ *		
4K (3840x2160)	4096	2160	59.94	593.407	✓		✓		✓	✓ *		
4K (3840x2160)	4096	2160	60	594.000	✓		✓		✓	✓ *		

* HDR is supported. (For HDR, HDR10 and HLG are supported.)

3D

Signal Format	Resolution (Dots)		V Sync (Hz)	Dotclk (MHz)	3D Format	HDMI						
						RGB		YCbCr				
								4:4:4		4:2:2		
						8	10, 12	8	10, 12	8	10, 12	
HDTV (720p)	1280	720	60	148.500	Frame Packing	✓	✓	✓	✓	✓	✓	
					74.250	Side by Side	✓	✓	✓	✓	✓	✓
					74.250	Top and Bottom	✓	✓	✓	✓	✓	✓
HDTV (720p)	1280	720	59.94	148.500	Frame Packing	✓	✓	✓	✓	✓	✓	
					74.250	Side by Side	✓	✓	✓	✓	✓	✓
					74.250	Top and Bottom	✓	✓	✓	✓	✓	✓
HDTV (720p)	1280	720	50	148.500	Frame Packing	✓	✓	✓	✓	✓	✓	
					74.250	Side by Side	✓	✓	✓	✓	✓	✓
					74.250	Top and Bottom	✓	✓	✓	✓	✓	✓

Signal Format	Resolution (Dots)		V Sync (Hz)	Dotclk (MHz)	3D Format	HDMI						
						RGB		YCbCr				
								4:4:4		4:2:2		
						8	10, 12	8	10, 12	8	10, 12	
HDTV (1080i)	1920	1080	60	148.500	Frame Packing							
					74.250	Side by Side	✓	✓	✓	✓	✓	✓
					74.250	Top and Bottom						
HDTV (1080i)	1920	1080	59.94	148.500	Frame Packing							
					74.250	Side by Side	✓	✓	✓	✓	✓	✓
					74.250	Top and Bottom						
HDTV (1080i)	1920	1080	50	148.500	Frame Packing							
					74.250	Side by Side	✓	✓	✓	✓	✓	✓
					74.250	Top and Bottom						
HDTV (1080p)	1920	1080	24	148.500	Frame Packing	✓	✓	✓	✓	✓	✓	
					74.250	Side by Side	✓	✓	✓	✓	✓	✓
					74.250	Top and Bottom	✓	✓	✓	✓	✓	✓
HDTV (1080p)	1920	1080	23.98	148.500	Frame Packing	✓	✓	✓	✓	✓	✓	
					74.250	Side by Side	✓	✓	✓	✓	✓	✓
					74.250	Top and Bottom	✓	✓	✓	✓	✓	✓
HDTV (1080p)	1920	1080	60	297.000	Frame Packing							
				148.500	Side by Side	✓	✓	✓	✓	✓	✓	
				148.500	Top and Bottom							
HDTV (1080p)	1920	1080	59.94	297.000	Frame Packing							
				148.500	Side by Side	✓	✓	✓	✓	✓	✓	
				148.500	Top and Bottom							
HDTV (1080p)	1920	1080	50	297.000	Frame Packing							
				148.500	Side by Side	✓	✓	✓	✓	✓	✓	
				148.500	Top and Bottom							



Specifications

EH-TW7100/EH-TW7000

* The following specifications are current as of April 2019. Details of accessories are subject to change without notice.

Product name		EH-TW7100	EH-TW7000
Appearance		410 (W) x 157 (H) x 310 (D) mm (not including adjustable foot)	
Panel Size		0.61" wide	
Display method		Polysilicon TFT active matrix	
Resolution		1920 (W) x 1080 (H) x 3	
Focus adjustment		Manual	
Zoom adjustment		Manual (Approx. 1 to 1.6)	
Lamp (light source)		UHE lamp 250 W, Model No.: ELPLP85	
Lamp life expectancy		When Power Consumption is set to High from the Image menu: approx. 3,500 hours When Power Consumption is set to Medium from the Image menu: approx. 4,000 hours When Power Consumption is set to ECO from the Image menu: approx. 5,000 hours	
Power supply		100 - 240 V AC \pm 10%, 50/60 Hz, 4.1 - 1.8 A	100 - 240 V AC \pm 10%, 50/60 Hz, 3.9 - 1.7 A
Power consumption	100 to 120 V area	Rated power consumption: 406 W	Rated power consumption: 386 W
		Standby power consumption (Communication On): 2.0 W (when using wireless LAN unit ELPAP10)	
		Standby power consumption (Communication Off): 0.5 W	
	220 to 240 V area	Rated power consumption: 387 W	Rated power consumption: 368 W
		Standby power consumption (Communication On): 2.0 W (when using wireless LAN unit ELPAP10)	
		Standby power consumption (Communication Off): 0.5 W	
Operating altitude		Altitude 0 to 3048 m	
Operating temperature		+5 to +35°C (No condensation) (at an altitude of 0 to 2286 m) +5 to +30°C (No condensation) (at an altitude of 2287 to 3048 m)	
Storage temperature		-10 to +60°C (No condensation)	
Mass		Approx. 6.9 kg	Approx. 6.6 kg
Speaker		10 W x 2	-

Connectors	HDMI port	2	HDMI HDCP2.2 supported, CEC signals supported, 3D signals supported, Linear PCM supported, Deep Color
	USB port* ¹	1	USB connector (Type A)
	2.0A power supply port* ¹	1	USB connector (Type A)
	Audio Out port	1	Stereo mini jack (3.5Φ)
	RS-232C port * ²	1	D-sub 9-pin (male)
	Trigger Out port * ²	1	Stereo mini jack (3.5Φ)
	Service port* ¹	1	USB connector (Type B)

*1 Supports USB 2.0. However, USB ports are not guaranteed to operate all devices that support USB.

*2 EH-TW7100 only.

This product is also designed for IT power distribution system with phase-to-phase voltage 230V.

Angle of tilt

If you use the projector tilted at an angle of more than 10°, the projector could be damaged or it may lead to an accident.

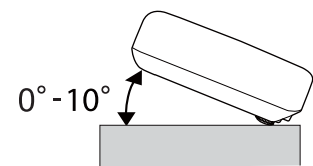

Supplier's DECLARATION of CONFORMITY

According to 47CFR, Part 2 and 15
Class B Personal Computers and Peripherals; and/or
CPU Boards and Power Supplies used with Class B Personal Computers

We: Epson America, Inc.
Located at: 3840 Kilroy Airport Way Long Beach, CA 90806
Tel: 562-981-3840

Declare under sole responsibility that the product identified herein, complies with 47CFR Part 2 and 15 of the FCC rules as a Class B digital device. Each product marketed, is identical to the representative unit tested and found to be compliant with the standards. Records maintained continue to reflect the equipment being produced can be expected to be within the variation accepted, due to quantity production and testing on a statistical basis as required by 47CFR 2.906. Operation is subject to the following two conditions : (1) this device may not cause harmful interference, and (2) this device must accept any interference received, including interference that may cause undesired operation.

Trade Name: EPSON
Type of Product: LCD Projector
Model: H959C/H961C
Options: Product name: Remote controller
model: 2198638xx (x=0-9)

**FCC Compliance Statement
For United States Users**

This device complies with part 15 of the FCC Rules. Operation is subject to the following two conditions: (1) This device may not cause harmful interference, and (2) this device must accept any interference received, including interference that may cause undesired operation.

This equipment has been tested and found to comply with the limits for a Class B digital device, pursuant to Part 15 of the FCC Rules. These limits are designed to provide reasonable protection against harmful interference in a residential installation. This equipment generates, uses, and can radiate radio frequency energy and, if not installed and used in accordance with the instructions, may cause harmful interference to radio communications.

However, there is no guarantee that interference will not occur in a particular installation. If this equipment does cause harmful interference to radio or television reception, which can be determined by turning the equipment off and on, the user is encouraged to try to correct the interference by one or more of the following measures.

- Reorient or relocate the receiving antenna.
- Increase the separation between the equipment and receiver.
- Connect the equipment into an outlet on a circuit different from that to which the receiver is connected.
- Consult the dealer or an experienced radio/TV technician for help.

WARNING

The connection of a non-shielded equipment interface cable to this equipment will invalidate the FCC Certification or Declaration of this device and may cause interference levels which exceed the limits established by the FCC for this equipment. It is the responsibility of the user to obtain and use a shielded equipment interface cable with this device. If this equipment has more than one interface connector, do not leave cables connected to unused interfaces. Changes or modifications not expressly approved by the manufacturer could void the user's authority to operate the equipment.



Appearance

Units: mm

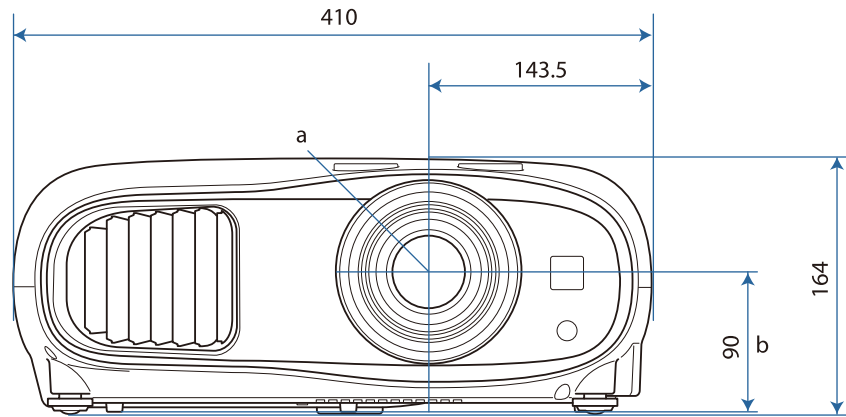



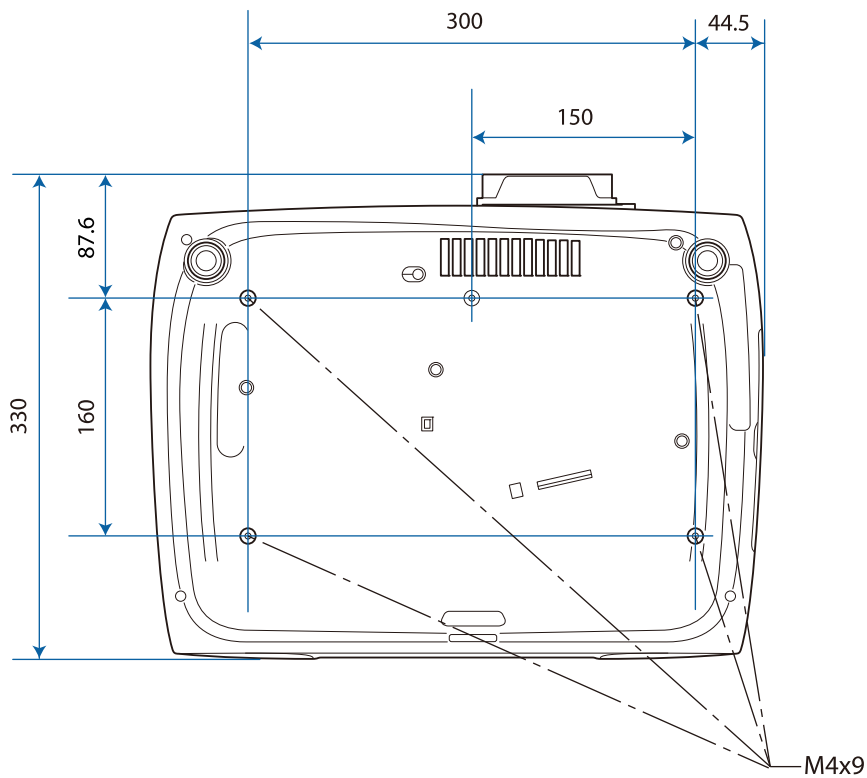



























- a Center of lens
- b Distance from center of lens to suspension bracket fixing point



List of Safety Symbols

The following table lists the meaning of the safety symbols labeled on the equipment.

Symbol mark	Approved standards	Meaning
	IEC60417 No. 5007	"ON" (power) To indicate connection to the mains.
	IEC60417 No. 5008	"OFF" (power) To indicate disconnection from the mains.
	IEC60417 No. 5009	Standby To identify the switch or switch position by means of which part of the equipment is switched on in order to bring it into the standby condition.
	ISO7000 No. 0434B IEC3864-B3.1	Caution To identify general caution when using the product.
	IEC60417 No. 5041	Caution, hot surface To indicate that the marked item can be hot and should not be touched without taking care.
	IEC60417 No. 6042 ISO3864-B3.6	Caution, risk of electric shock To identify equipment that has risk of electric shock.
	IEC60417 No. 5957	For indoor use only To identify electrical equipment designed primarily for indoor use.
	IEC60417 No. 5926	Polarity of d.c. power connector To identify the positive and negative connections (the polarity) on a piece of equipment to which a d.c. power supply may be connected.
	---	
	IEC60417 No. 5001B	Battery, general On battery powered equipment. To identify a device for instance a cover for the battery compartment, or the connector terminals.
	IEC60417 No. 5002	Positioning of cell To identify the battery holder itself and to identify the positioning of the cell(s) inside the battery holder.
	---	
	IEC60417 No. 5019	Protective earth To identify any terminal which is intended for connection to an external conductor for protection against electric shock in case of a fault, or the terminal of a protective earth electrode.
	IEC60417 No. 5017	Earth To identify an earth (ground) terminal in cases where neither the symbol  is explicitly required.

Symbol mark	Approved standards	Meaning
	IEC60417 No. 5032	Alternating current To indicate on the rating plate that the equipment is suitable for alternating current only; to identify relevant terminals.
	IEC60417 No. 5031	Direct current To indicate on the rating plate that the equipment is suitable for direct current only; to identify relevant terminals.
	IEC60417 No. 5172	Class II equipment To identify equipment meeting the safety requirements specified for Class II equipment according to IEC 61140.
	ISO 3864	General prohibition To identify actions or operations that are prohibited.
	ISO 3864	Contact prohibition To indicate injury that could occur due to touching a specific part of the equipment.
	---	Never look into the projection lens while the projector is on.
	---	To indicate that the marked item don't place anything on projector.
	ISO3864 IEC60825-1	Caution, laser radiation To indicate the equipment has a laser radiation part.
	ISO 3864	Disassembly prohibition To indicate a risk of injury, such as electric shock, if the equipment is disassembled.
	IEC60417 No. 5266	Standby, partial standby To indicate that part of the equipment is in the ready status.
	ISO3864 IEC60417 No. 5057	Caution, movable parts To indicate that you must keep away from movable parts according to protection standards.
	IEC 60417-6056	Caution (movable fan blades) To indicate that you must keep away from the blades of the movable fan according to protection standards.
	IEC 60417-6043	Caution (sharp corners) To indicate that you must not touch the sharp corners of the product according to protection standards.
	--	Never look into the projection lens while the projector is on.
	ISO7010 No. W027 ISO 3864	Warning, light emission (UV, visible light, IR and so on) To indicate that you must be careful not to injure your eyes or skin when near light emitting sections.
	IEC60417 No.5109	Not to be used in residential areas To indicate that the electrical equipment/device is not suitable for use in a residential area.



Glossary

This section briefly explains the difficult terms that are not explained in context in the text of this guide. For details, refer to other commercially available publications.

4K	This provides a high-quality image with a screen comprised of a 3840 x 2160 pixels.
Aspect Ratio	The ratio between an image's length and its height. Screens with a horizontal:vertical ratio of 16:9, such as HDTV screens, are known as wide screens. SDTV and general computer displays have an aspect ratio of 4:3.
HDCP	HDCP is an abbreviation for High-bandwidth Digital Content Protection. It is used to prevent illegal copying and protect copyrights by encrypting digital signals sent over DVI and HDMI ports. Because the HDMI port on this projector supports HDCP, it can project digital images protected by HDCP technology. However, the projector may not be able to project images protected with updated or revised versions of HDCP encryption.
HDMI™	An abbreviation for High Definition Multimedia Interface. This is the standard by which HD images and multichannel audio signals are digitally transmitted. HDMI™ is a standard aimed at digital consumer electronics and computers. By not compressing the digital signal, the image can be transferred at the highest quality possible. It also provides an encryption function for the digital signal.
HDTV	An abbreviation for High-Definition Television. This refers to high-definition systems which satisfy the following conditions. <ul style="list-style-type: none"> • Vertical resolution of 720p or 1080i or greater (p = Progressive, i = Interlace) • Screen aspect of 16:9 Dolby Digital audio reception and playback (or output)
Interlace	Transmits information needed to create one screen by sending every other line, starting from the top of the image and working down to the bottom. Images are more likely to flicker because one frame is displayed every other line.
Pairing	Register devices in advance when connecting with Bluetooth devices to ensure mutual communication.
SDTV	An abbreviation for Standard Definition Television. This refers to standard television systems which do not satisfy the conditions for HDTV High-Definition Television.
SVGA	A screen size standard with a resolution of 800 (horizontal) x 600 (vertical) dots.
SXGA	A screen size standard with a resolution of 1,280 (horizontal) x 1,024 (vertical) dots.
VGA	A screen size standard with a resolution of 640 (horizontal) x 480 (vertical) dots.
XGA	A screen size standard with a resolution of 1,024 (horizontal) x 768 (vertical) dots.
YCbCr	In component image signals for SDTV, Y is the brightness, while Cb and Cr indicate the color difference.
YPbPr	In component image signals for HDTV, Y is the brightness, while Pb and Pr indicate the color difference.

General Notes

All rights reserved. No part of this publication may be reproduced, stored in a retrieval system, or transmitted in any form or by any means, electronic, mechanical, photocopying, recording, or otherwise, without the prior written permission of Seiko Epson Corporation. No patent liability is assumed with respect to the use of the information contained herein. Neither is any liability assumed for damages resulting from the use of the information contained herein.

Neither Seiko Epson Corporation nor its affiliates shall be liable to the purchaser of this product or third parties for damages, losses, costs, or expenses incurred by the purchaser or third parties as a result of: accident, misuse, or abuse of this product or unauthorized modifications, repairs, or alterations to this product, or (excluding the U.S.) failure to strictly comply with Seiko Epson Corporation's operating and maintenance instructions.

Seiko Epson Corporation shall not be liable against any damages or problems arising from the use of any options or any consumable products other than those designated as Original Epson Products or Epson Approved Products by Seiko Epson Corporation.

The contents of this guide may be changed or updated without further notice.

Illustrations in this guide and the actual projector may differ.

Restriction of Use





When this product is used for applications requiring high reliability/safety such as transportation devices related to aviation, rail, marine, automotive etc.; disaster prevention devices; various safety devices etc; or functional/precision devices etc, you should use this product only after giving consideration to including fail-safes and redundancies into your design to maintain safety and total system reliability. Because this product was not intended for use in applications requiring extremely high reliability/safety such as aerospace equipment, main communication equipment, nuclear power control equipment, or medical equipment related to direct medical care etc, please make your own judgment on this product's suitability after a full evaluation.



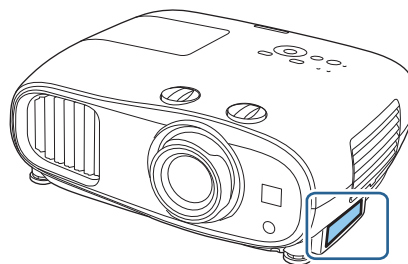

Warning Labels

Warning

- This product comes with warning labels.



	WARNING
 RG2	WARNING: Never look into the lens. AVERTISSEMENT : Ne regardez jamais dans l'objectif. WARNUNG : Blicken Sie niemals in das Objektiv.
	CAUTION
	CAUTION: Do not put your finger in the moving parts of the projector's lens. ATTENTION : Ne pas mettre le doigt dans les parties mobiles de l'objectif du projecteur. ACHTUNG: Vermeiden Sie den Kontakt mit beweglichen Teilen der Linse.

	WARNING
 RG2	WARNING: Never look into the lens. 경고: 작동중 절대 렌즈 인을 보지 마십시오. 警語: 請勿直視鏡頭。
	CAUTION
	CAUTION: Do not put your finger in the moving parts of the projector's lens. 주의: 프로젝터 렌즈의 움직이는 부분에 손가락을 넣지 마세요. 注意: 請勿將手指伸入投影機鏡頭的移動式零件內。

- As with any bright source, do not stare into the beam, RG2 IEC/EN 62471-5:2015.

General Notice

"EPSON" is a registered trademark of Seiko Epson Corporation. "EXCEED YOUR VISION" and "ELPLP" are registered trademarks or trademarks of Seiko Epson Corporation.

iPad, iPhone, Mac ,OS X, and iOS are trademarks of Apple Inc.

Windows and the Windows logo are trademarks or registered trademarks of Microsoft Corporation in the United States and/or other countries.

HDMI, the HDMI Logo and High-Definition Multimedia Interface are the trademarks or registered trademarks of HDMI Licensing LLC. 

The Bluetooth® word mark and logo are registered trademarks of Bluetooth SIG, Inc., and the Seiko Epson Corporation uses these marks under license. Other trademarks or trade names are the property of their respective owners.

Bluetopia® is provided for your use by Stonestreet One, LLC® under a software license agreement. Stonestreet One, LLC® is and shall remain the sole owner of all right, title and interest whatsoever in and to Bluetopia® and your use is subject to such ownership and to the license agreement. Stonestreet One, LLC® reserves all rights related to Bluetopia® not expressly granted under the license agreement and no other rights or licenses are granted either directly or by implication, estoppel or otherwise, or under any patents, copyrights, mask works, trade secrets or other intellectual property rights of Stonestreet One, LLC®.

© 2000-2012 Stonestreet One, LLC® All Rights Reserved.

Qualcomm aptX is a product of Qualcomm Technologies, Inc. and/or its subsidiaries.

Qualcomm is a trademark of Qualcomm Incorporated, registered in the United States and other countries. aptX is a trademark of Qualcomm Technologies International, Ltd., registered in the United States and other countries.

WPA™ and WPA2™ are registered trademarks of the Wi-Fi Alliance.

App Store is a service mark of Apple Inc.

Android and Google Play are trademarks of Google LLC.

"QR Code" is a registered trademark of DENSO WAVE INCORPORATED.

CinemaScope a registered trademark of Twentieth Century Fox Film Corporation.

Other product names used herein are also for identification purposes only and may be trademarks of their respective owners. Epson disclaims any and all rights in those marks.

©SEIKO EPSON CORPORATION 2021. All rights reserved.



Indication of the manufacturer and the importer in accordance with requirements of directive 2011/65/EU (RoHS)

Manufacturer: SEIKO EPSON CORPORATION

Address: 3-5, Owa 3-chome, Suwa-shi, Nagano-ken 392-8502 Japan

Telephone: 81-266-52-3131

<http://www.epson.com/>

Importer: EPSON EUROPE B.V.

Address: Atlas Arena, Asia Building, Hoogoorddreef 5, 1101 BA Amsterdam
Zuidoost The Netherlands

Telephone: 31-20-314-5000

<http://www.epson.eu/>

- 3**
- 3D brightness 61
 - 3D display 61
 - 3D format 61
 - 3D Glasses 47
 - 3D images 46
 - 3D setup 61
 - 3D viewing notice 61
- A**
- A/V mute 33
 - Adjust lens shift 7
 - Adjusting focus 28
 - Adjusting RGB 40
 - Adjusting the position of the image 29
 - Adjusting the tilt 29
 - Advanced 60, 62
 - Air filter 84, 86
 - Air filter cover 84, 87
 - Air filter replacement period 86
 - Appearance 102
 - Aspect 34, 61
 - Audio 62
 - Auto iris 38, 60
- B**
- Basic menu 68
 - Blanking 62
 - Bluetooth 63
 - Brightness 41, 59, 60
- C**
- CEC standards 49
 - Channel 69
 - Child lock 64
 - Cleaning the air filter 84
 - Cleaning the lens 86
 - Cleaning the main unit 85
 - Color depth 70
 - Color format 70
 - Color mode 34, 59
 - Color saturation 59
 - Color Space 61
 - Color Uniformity 92
 - Color uniformity 65
 - Configuration menu 58
 - Connecting 20
 - Connecting a computer 20
 - Connecting Bluetooth devices 21
 - Connecting external equipment 20
 - Connecting external speakers 23
 - Connecting to the Trigger Out port 20
 - Connecting video equipment 20
 - Connection mode 69
 - Contrast 59
 - Control panel 7, 8
 - Control panel lock 64
 - Cool-down 27
- D**
- Detail Enhancement 60
 - Detail enhancement 37
 - DHCP 69
 - Direct power on 66
 - Display 65
 - Display background 65
 - Display LAN info. 68
 - Display the QR code 67
 - Displaying the test pattern 28
 - Dynamic range 61
- E**
- Error/Warning indicators 71
 - Event ID 82
 - Extended menu 65
- F**
- Fine Line Adjust 37
 - Fine line adjust 60
 - Focus 76
 - Focus adjustment 28
 - Focus ring 7, 28
 - Frame interpolation 38, 60
 - Full 34
- G**
- Gain 40, 59
 - Gamma 42, 60
 - Gateway address 69
- H**
- H/V-Keystone 30
 - HDMI link 49, 63
 - HDMI port 12, 49
 - High altitude mode 66
 - Home screen 26, 65
 - Hue 41, 60
- I**
- Illumination 66
 - Image 34
 - Image enhancement 37, 60

- Image menu 59
 - Image processing 39, 62
 - Indicators 71
 - Info menu 70
 - Inverse 3D glasses 61
 - Inverse audio 62
 - IP address 69
 - IP address display 69
 - IP settings 69
- K**
- Keystone 62
 - Keystone distortion 30, 62
- L**
- Lamp cover 7, 88
 - Lamp cover fixing screw 88
 - Lamp hours 70
 - Lamp replacement period 86
 - Language 66
 - Lens shift dial 29
 - Load memory 44
 - Lock setting 64
- M**
- Memory 64
 - Memory function 44
 - Menu 58
 - Messages 65
 - MPEG noise reduction 37
 - Mute 33
- N**
- Network menu 67
 - Noise 76
 - Noise Reduction 60
 - Noise reduction 37
- O**
- Offset 40, 59
 - Operating range 24
 - Operating time 70, 89
 - Operation 66
 - Overscan 61
- P**
- Panel Alignment 90
 - Panel alignment 65, 67
 - Passphrase 69
 - Power 27
 - Power consumption 60
 - Power supply 25
 - Projection 65
 - Projection size 29
 - Projector info 70
 - Projector name 68
- Q**
- Quick Corner 32
- R**
- Remote control 10, 24
 - Remote password 68
 - Replacement periods for consumables 86
 - Replacement time 86
 - Replacing consumables 86
 - Replacing the air filter 86
 - Replacing the lamp 87
 - Reset 60, 62, 64, 66
 - Reset all config 70
 - Reset lamp hours 70, 89
 - Reset memory 70
 - Reset menu 70
 - RGBCMY 41, 60
- S**
- Saturation 41, 60
 - Save memory 44
 - Search access point 69
 - Security 54, 69
 - Security menu 69
 - Settings menu 62
 - Sharpness 36, 59
 - Signal menu 61
 - Sleep mode 66
 - Soft Focus Detail 37
 - Soft focus detail 60
 - Soft keyboard 68
 - Source 26
 - Specifications 99
 - SSID 69
 - SSID display 69
 - Standby mode 66
 - Startup screen 65
 - Sub menu 58
 - Subnet mask 69
 - Super-resolution 37, 60
 - Supported resolutions 95
- T**
- Tint 59
 - Top menu 58

U

User button 64

V

Version 70

Volume 33, 62

W

White balance 59

Wireless LAN menu 69

Wireless LAN power 67

Wireless LAN unit 23

Z

Zoom 34

Zoom adjustment 29

Zoom ring 7, 29