

Dear Customer,

We design and produce our product for people to love and have fun with them as we do.

The product you bought was subjected to all sorts of tests and control before sending out to you.

Before start assembling, please check the whole components and accessories according to the lists. If you bought more than one product, to prevent confusion be sure that you completed the first product. Then start the other product's assembling.

Before start assembling, please clean all the components with a damp cloth. Also for usual cleaning, this will be enough.

Although all the products are produced and packed carefully, sometimes happen that some component is damaged during the transportation. In such a case please check the missing or damaged part and do not hesitate to contact us.

Do not use furniture for other purposes. If you would like to use it, please contact us for further questions.









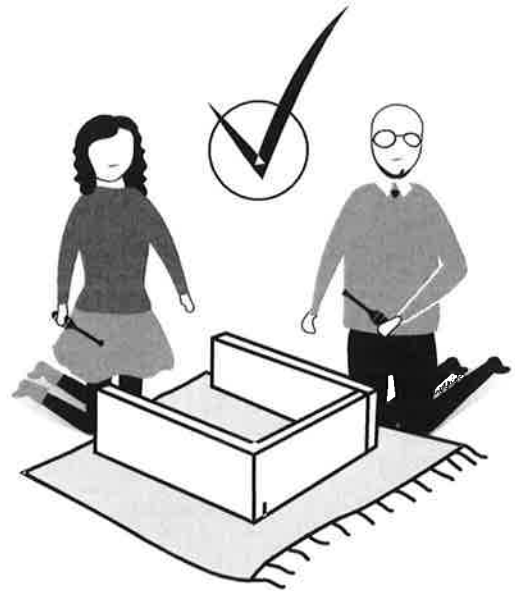
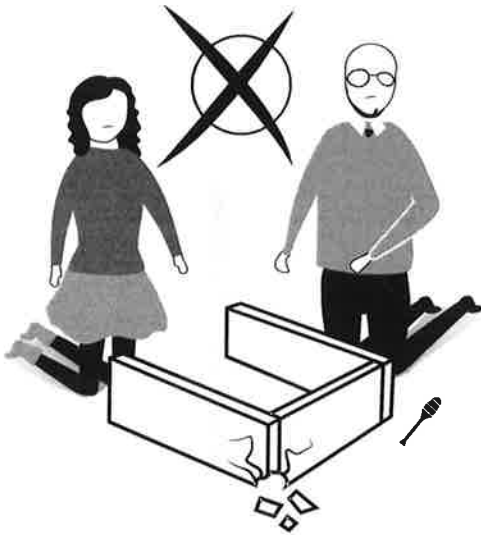

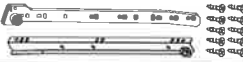

Do not directly contact your furniture with excessive heat, cold and humidity because the product can be affected.

WARNING

Serious or fatal crushing injuries can occur from furniture tip-over. To prevent this furniture from tipping over it must be permanently fixed to the wall with the included wall attachment devices.

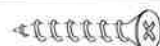
Fixing devices for the wall are not included since different wall materials require different types of fixing devices. Use fixing devices suitable for the walls in your home. For advice on suitable fixing systems, contact your local specialized dealer.

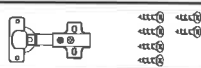
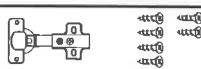

HARDWARE LIST			
NO	DESCRIPTION		QTY
I	JCBCW SCREW M6.3 x 50		18pcs
II	M4 ALLEN KEY		1pc
III	HANDLE & SCREW M3.5 x 30		4sets
IV	12" DRAWER SLIDER & SCREW M3.5 x 14		1sets
V	M8 x 30 WOOD DOWEL		8pcs
VI	Q-FIT		10sets
VII	NAIL		60pcs
VIII	PVC NAIL WITH PIN		6pcs
IX	STICKER		10pcs
X	SHELF SUPPORT		28pcs
XI	M8 x 32 CHIPBOARD SCREW		4pcs
XII	DRAWER SUPPORT & SCREW M3.5 x 14		4sets
XIII	HINGE (A) & SCREW M3.5 x 14		4sets
XIV	HINGE (B) & SCREW M3.5 x 14		2sets
XV	L BRACKET & SCREW M3.5 x 14		2sets

STEP 1

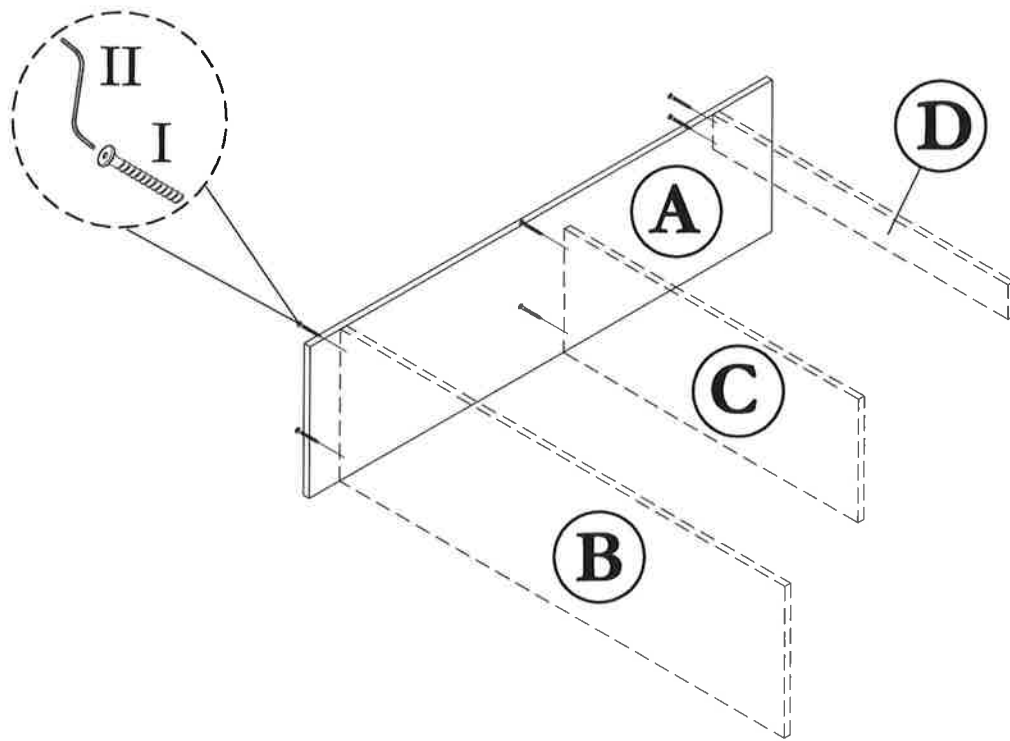

STEP 2

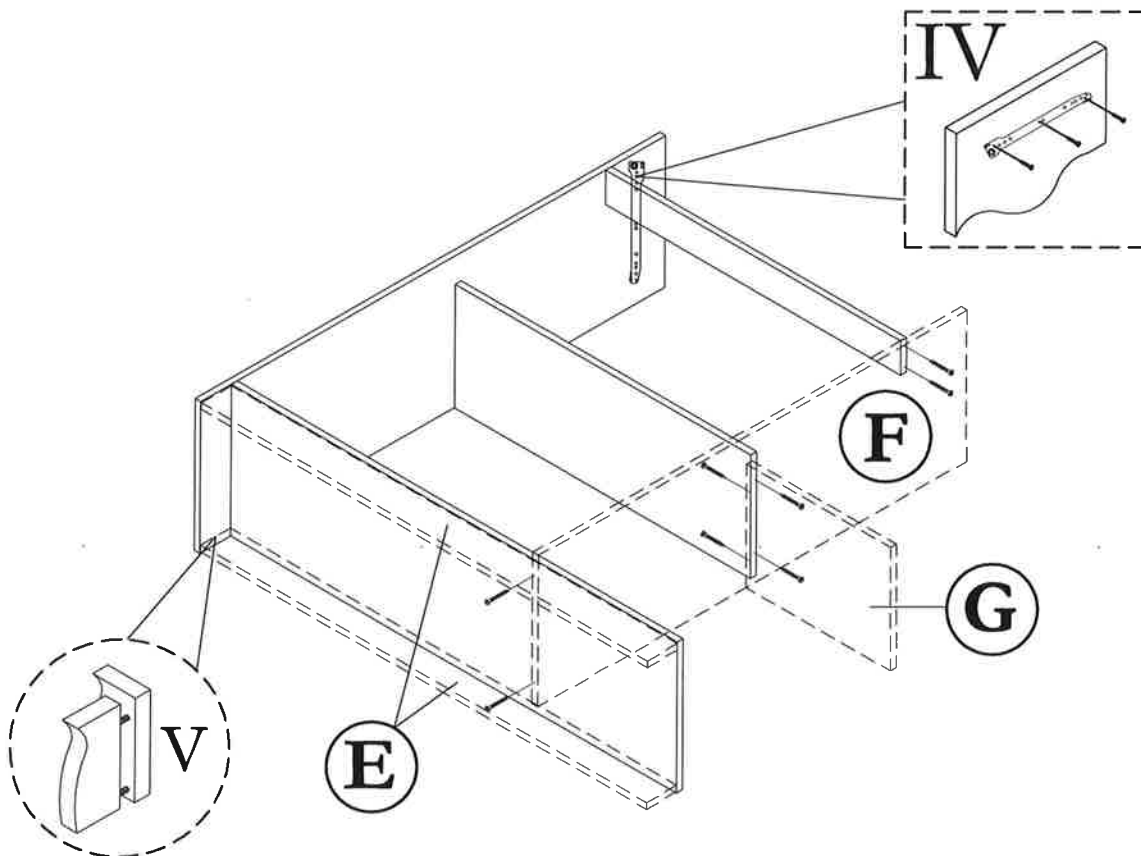

STEP 3

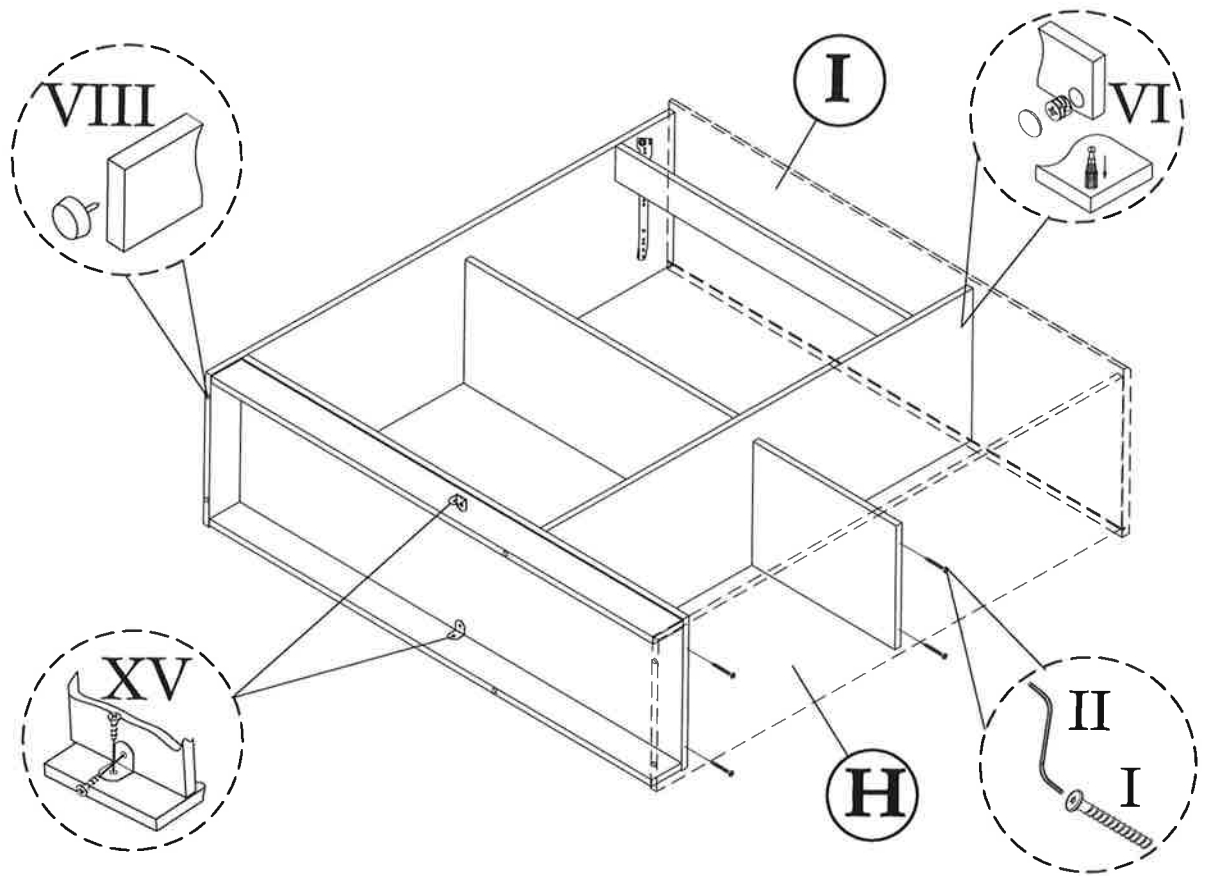

STEP 4

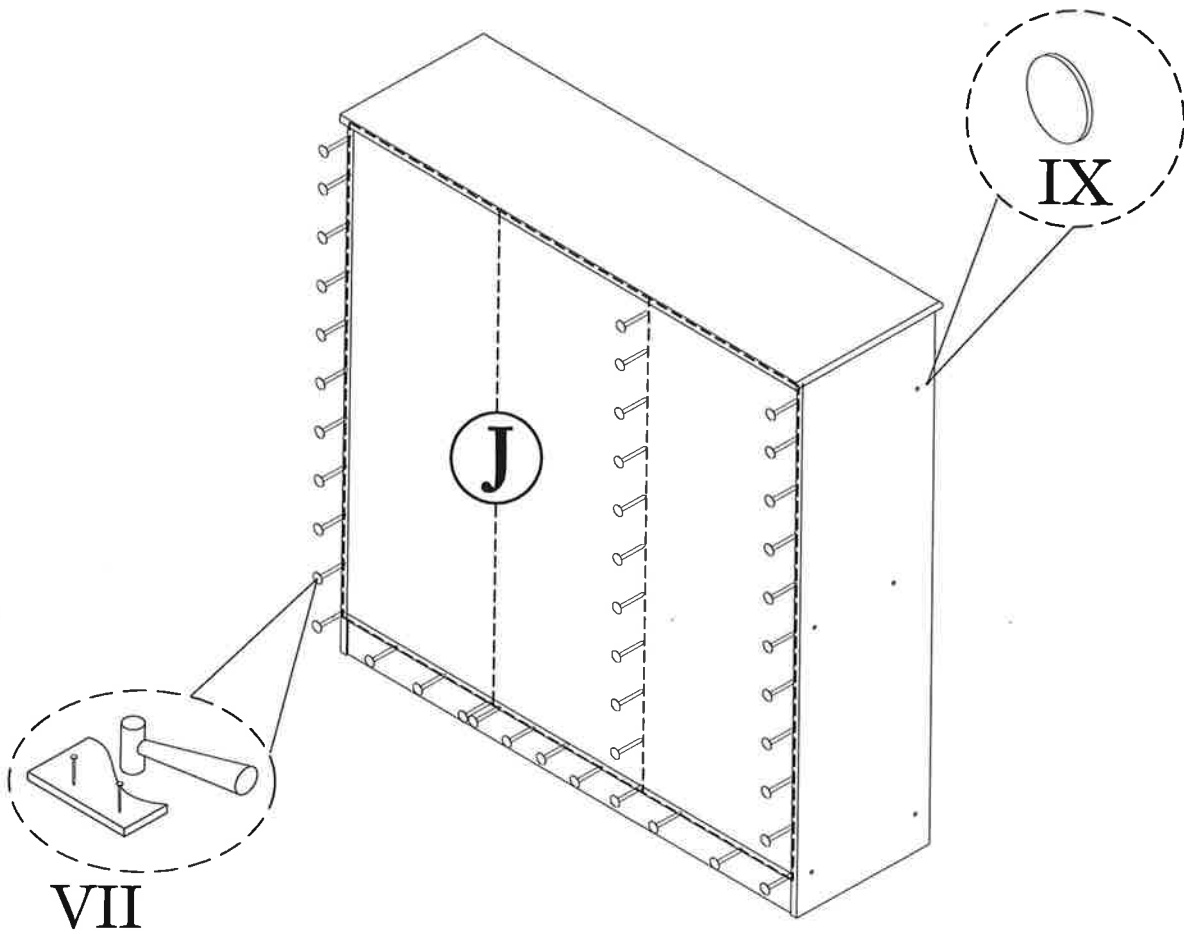

STEP 5

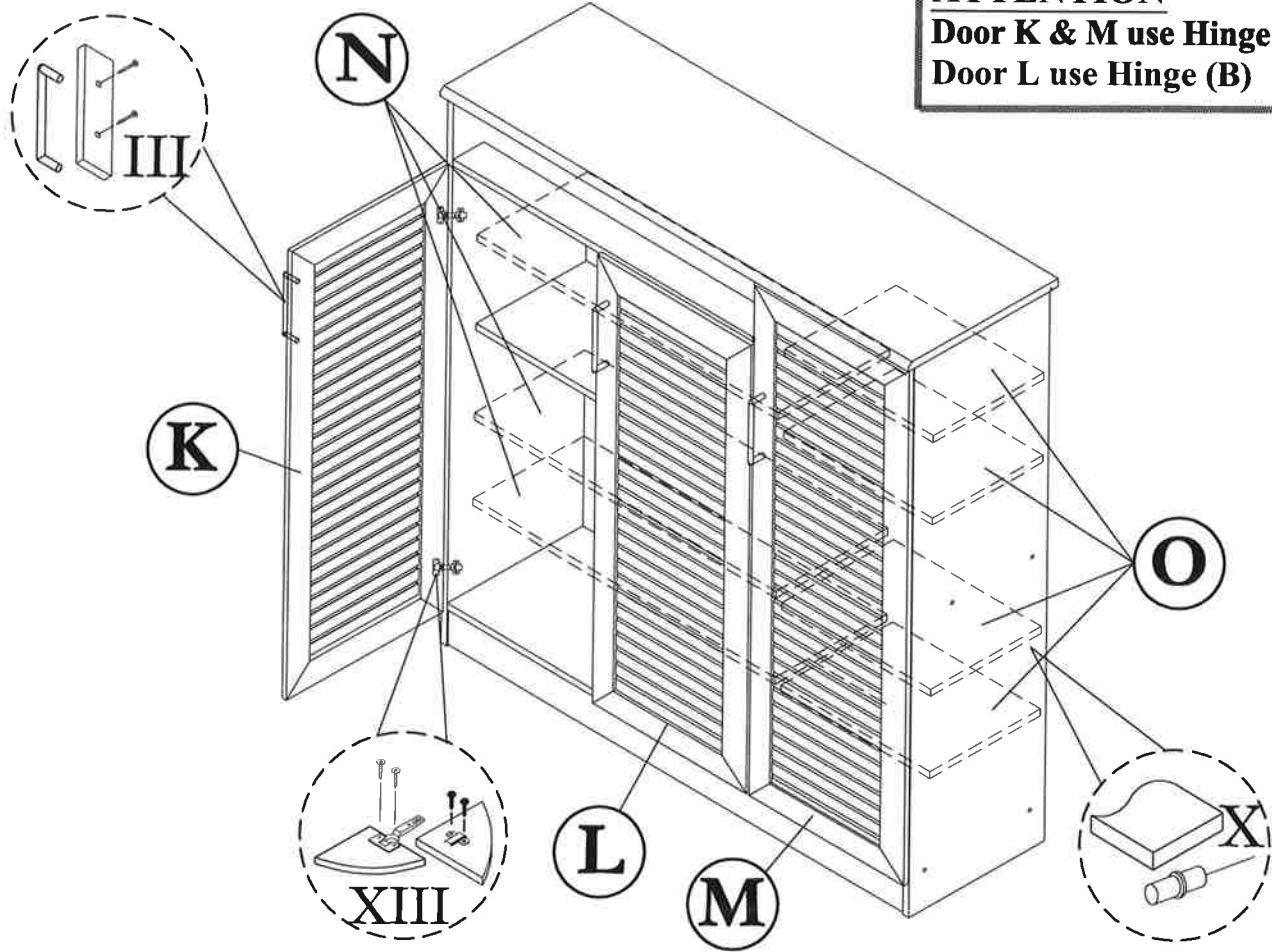

ATTENTION
Door K & M use Hinge (A)
Door L use Hinge (B)

STEP 6

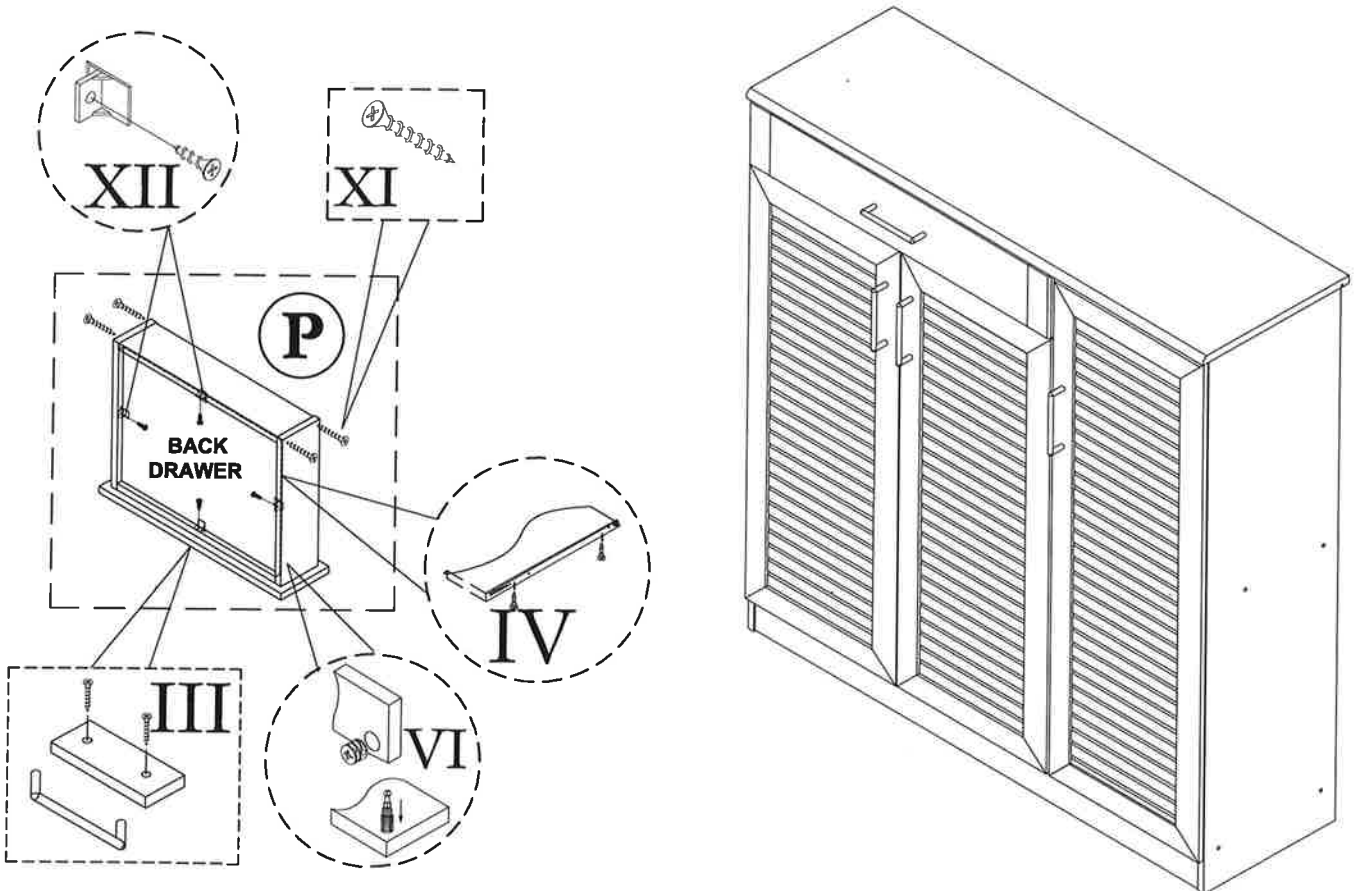

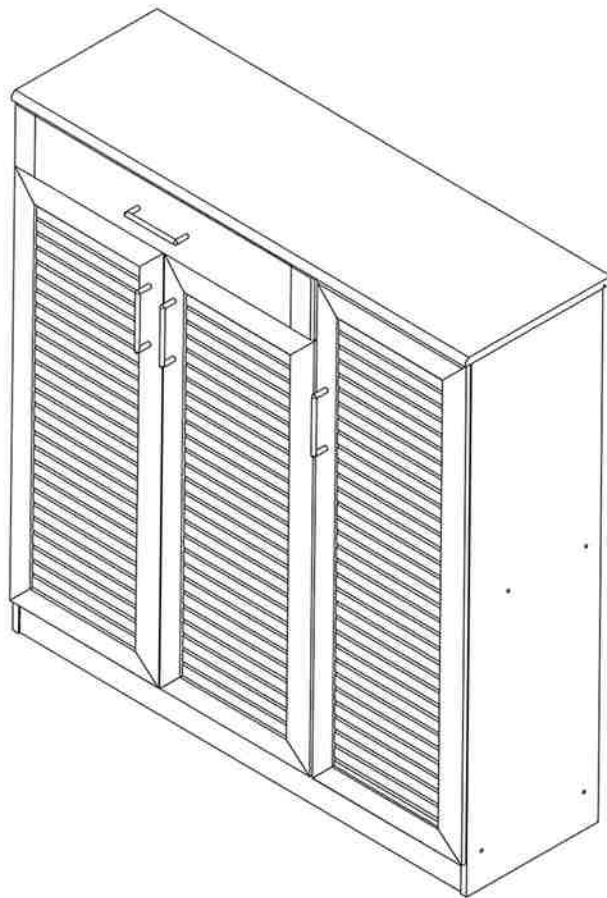

COMPLETE SET

NO	DESCRIPTION	QTY
A	LEFT SIDE	01
B	LOWER SHELF	01
C	CENTRE SHELF (LEFT)	01
D	HORIZONTAL SHELF	01
E	LEG	02
F	CENTRE VERTICAL	01
G	CENTRE SHELF (RIGHT)	01
H	RIGHT SIDE	01
I	TOP	01
J	BACK	03
K	LEFT SIDE DOOR	01
L	CENTRE DOOR	01
M	RIGHT SIDE DOOR	01
N	MOVABLE SHELF (LEFT)	03
O	MOVABLE SHELF (RIGHT)	04
P	DRAWER FACE	01

