

# USER MANUAL

## SAFETY INSTRUCTIONS

Before using the appliance, read these safety instructions. Keep them nearby for future reference.

These instructions and the appliance itself provide important safety warnings, to be observed at all times. The manufacturer declines any liability for failure to observe these safety instructions, for inappropriate use of the appliance or incorrect setting of controls.

⚠ Very young children (0-3 years) should be kept away from the appliance. Young children (3-8 years) should be kept away from the appliance unless continuously supervised. Children from 8 years old and above and persons with reduced physical, sensory or mental capabilities or lack of experience and knowledge can use this appliance only if they are supervised or have been given instructions on safe use and understand the hazards involved. Children must not play with the appliance. Cleaning and user maintenance must not be carried out by children without supervision.

⚠ **WARNING:** The appliance and its accessible parts become hot during use. Care should be taken to avoid touching heating elements. Children less than 8 years of age must be kept away unless continuously supervised.

⚠ Never leave the appliance unattended during food drying. If the appliance is suitable for probe usage, only use a temperature probe recommended for this oven - risk of fire.

⚠ Keep clothes or other flammable materials away from the appliance, until all the components have cooled down completely - risk of fire. Always be vigilant when cooking foods rich in fat, oil or when adding alcoholic beverages - risk of fire. Use oven gloves to remove pans and accessories. At the end of cooking, open the door with caution, allowing hot air or steam to escape gradually before accessing the cavity - risk of burns. Do not obstruct hot air vents at the front of the oven - risk of fire.

⚠ Exercise caution when the oven door is in the open or down position, to avoid hitting the door.

### PERMITTED USE

⚠ **CAUTION:** The appliance is not intended to be operated by means of an external switching device, such as a timer, or separate remote controlled system.

⚠ This appliance is intended to be used in household and similar applications such as: staff kitchen areas in shops, offices and other working environments; farm houses; by clients in hotels, motels, bed & breakfast and other residential environments.

⚠ No other use is permitted (e.g. heating rooms).

## IMPORTANT TO BE READ AND OBSERVED

⚠ This appliance is not for professional use. Do not use the appliance outdoors.

⚠ Do not store explosive or flammable substances (e.g. gasoline or aerosol cans) inside or near the appliance - risk of fire.

### INSTALLATION

⚠ The appliance must be handled and installed by two or more persons - risk of injury. Use protective gloves to unpack and install - risk of cuts.

⚠ Installation, including water supply (if any) and electrical connections, and repairs must be carried out by a qualified technician. Do not repair or replace any part of the appliance unless specifically stated in the user manual. Keep children away from the installation site. After unpacking the appliance, make sure that it has not been damaged during transport. In the event of problems, contact the dealer or your nearest After-sales Service. Once installed, packaging waste (plastic, styrofoam parts etc.) must be stored out of reach of children - risk of suffocation. The appliance must be disconnected from the power supply before any installation operation - risk of electrical shock. During installation, make sure the appliance does not damage the power cable - risk of fire or electrical shock. Only activate the appliance when the installation has been completed.

⚠ Carry out all cabinet cutting works before fitting the appliance in the furniture and remove all wood chips and sawdust. Do not obstruct the minimum gap between the worktop and the upper edge of the oven - risk of burns.

Do not remove the oven from its polystyrene foam base until the time of installation.

⚠ After installation, the bottom of the appliance must no longer be accessible - risk of burn.

⚠ Do not install the appliance behind a decorative door - risk of fire.

### ELECTRICAL WARNINGS

⚠ The rating plate is on the front edge of the oven (visible when the door is open).

⚠ It must be possible to disconnect the appliance from the power supply by unplugging it if plug is accessible, or by a multi-pole switch installed upstream of the socket in accordance with the wiring rules and the appliance must be earthed in conformity with national electrical safety standards.

⚠ Do not use extension leads, multiple sockets or adapters. The electrical components must not be accessible to the user after installation. Do not use the appliance when you are wet or barefoot. Do not operate this appliance if it has a damaged power cable or plug, if it is not working properly, or if it has been damaged or dropped.

⚠ If the supply cord is damaged, it must be replaced with an identical one by the manufacturer, its service agent or similarly qualified persons in order to avoid a hazard - risk of electrical shock.

⚠ In case of replacement of power cable, contact an authorized service center.

#### **CLEANING AND MAINTENANCE**

⚠ **WARNING:** Ensure that the appliance is switched off and disconnected from the power supply before performing any maintenance operation; never use steam cleaning equipment - risk of electric shock.

⚠ Do not use harsh abrasive cleaners or metal scrapers to clean the door glass since they can scratch the surface, which may result in shattering of the glass.

⚠ Ensure the appliance is cooled down before any cleaning or maintenance. - risk of burn.

⚠ **WARNING:** Switch off the appliance before replacing the lamp - risk of electrical shock.

#### **DISPOSAL OF PACKAGING MATERIALS**

The packaging material is 100% recyclable and is marked with the recycle symbol . The various parts of the packaging must therefore be disposed of responsibly and in full compliance with local authority regulations governing waste disposal.

#### **DISPOSAL OF HOUSEHOLD APPLIANCES**

This appliance is manufactured with recyclable or reusable materials. Dispose of it in accordance with local waste disposal regulations. For further information on the treatment, recovery and recycling of household electrical appliances, contact your local authority, the collection service for household waste or the store where you purchased the appliance. This appliance is marked in compliance with European Directive 2012/19/EU, Waste Electrical and Electronic Equipment (WEEE). By ensuring this product is disposed of correctly, you will help prevent negative consequences for the environment and human health.

The  symbol on the product or on the accompanying documentation indicates that it should not be treated as domestic waste but must be taken to an appropriate collection center for the recycling of electrical and electronic equipment.

#### **ENERGY SAVING TIPS**

Only preheat the oven if specified in the cooking table or your recipe. Use dark lacquered or enamelled baking trays as they absorb heat better. Food requiring prolonged cooking will continue to cook even once the oven is switched off.

#### **ECO DESIGN DECLARATION**

This appliance meets the Eco Design requirements of European Regulations n.65/2014 and 66/2014 in conformity to the European standard EN 60350-1.

# PRODUCT DESCRIPTION

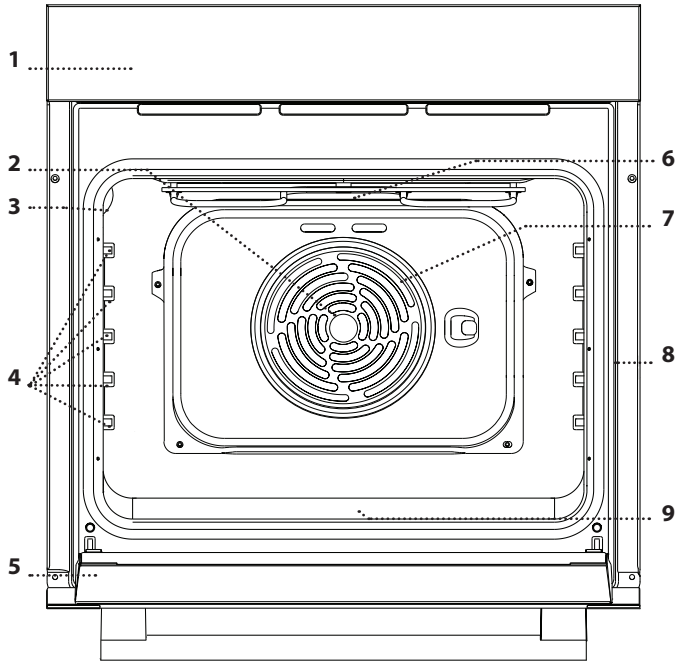

- 1. Control panel**
- 2. Fan**
- 3. Lamp**
- 4. Shelf guides**  
(the level is indicated on the wall of the cooking compartment)
- 5. Door**
- 6. Upper heating element/grill**
- 7. Circular heating element**  
(non-visible)
- 8. Identification plate**  
(do not remove)
- 9. Bottom heating element**  
(non-visible)

# CONTROL PANEL

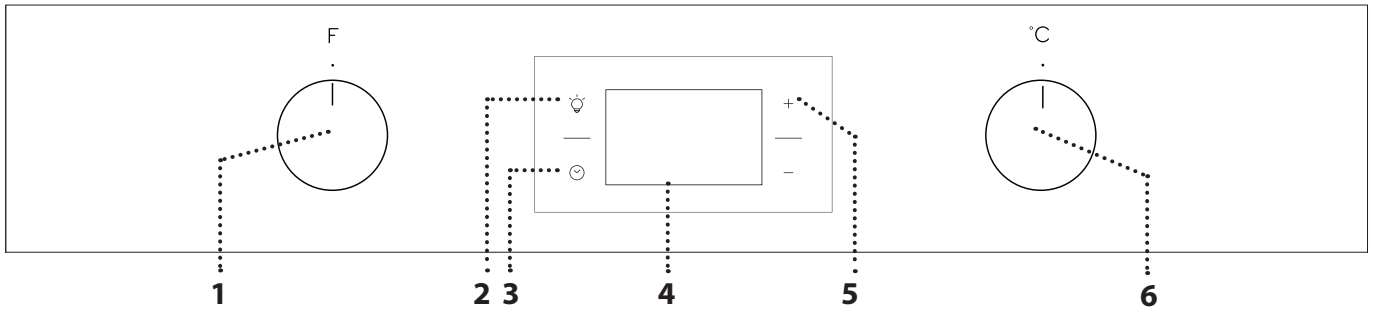

## 1. SELECTION KNOB

For switching the oven on by selecting a function. Turn to the **O** position to switch the oven off.

## 2. LIGHT

With the oven switched on, press to turn the oven compartment lamp on or off.

## 3. SETTING THE TIME

For accessing the cooking time settings, delayed start and timer. For displaying the time when the oven is off.

## 4. DISPLAY

## 5. ADJUSTMENT BUTTONS

For changing the cooking time settings.

## 6. THERMOSTAT KNOB

Turn to select the temperature you require when activating manual functions. For "Turn & Cook" function keep on **●**.

Please note: The knobs are retractable. Press the knobs in the middle and they pop up.

# DESCRIPTION OF DISPLAY

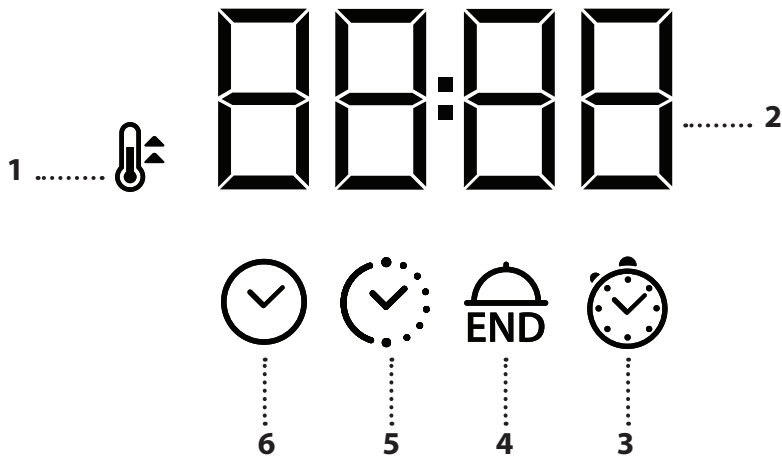

1. Preheating symbol
2. Clock; information and function duration
3. Kitchen timer
4. End of cooking time
5. Duration
6. Clock

# ACCESSORIES

## WIRE SHELF

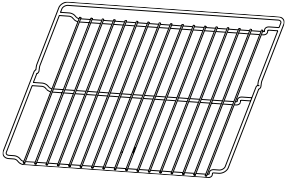

The wire shelf can be used to grill food or as a support for pans, cake tins and other ovenproof cooking receptacles. Useful for grilling bread, meat, fish and vegetables.

## DRIP TRAY \*

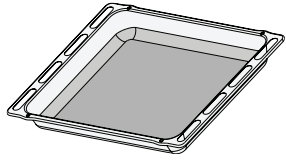

Use as an oven tray for cooking meat, fish, vegetables, focaccia, etc. or position underneath the wire shelf to collect cooking juices.

## BAKING TRAY \*

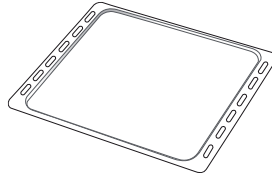

Use for cooking all bread and pastry products, but also for roasts, fish en papillote, etc.

## SLIDING RUNNERS \*

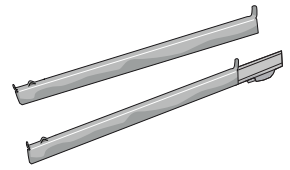

These make it easier to place accessories in and remove accessories from the oven.

\* Available only on certain models

The number of accessories may vary depending on which model is purchased.

ADDITIONAL ACCESSORIES: Other accessories that are not supplied can be purchased separately from the After-sales Service.

## INSERTING THE WIRE SHELF AND OTHER ACCESSORIES

- Insert the wire shelf horizontally by sliding it across the shelf guides, making sure that the side with the raised edge is facing upwards.

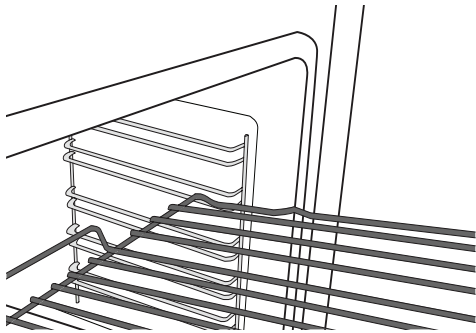

- The other accessories, such as the baking tray, are inserted horizontally in the same way as the wire shelf.

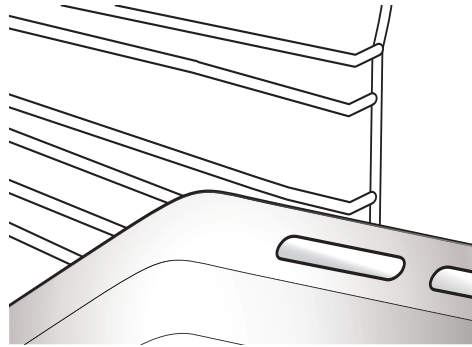

## REMOVING AND REFITTING THE SHELF GUIDES

• **To remove the shelf guides**, firmly grip the external part of the guide, and pull it towards you to extract the support and the two internal pins from the lodging.

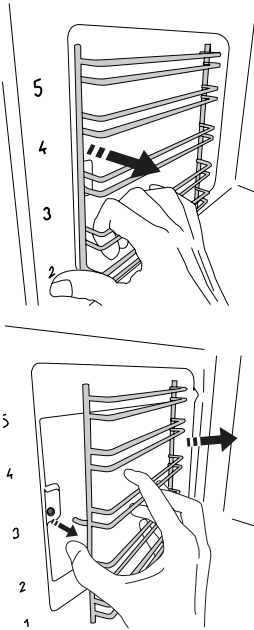

• **To reposition the shelf guides**, position them near the cavity and initially insert the two pins into their lodgings. Next, position the external part near its lodging, insert the support, and firmly press towards the wall of the cavity to make sure the shelf guide is properly secured.

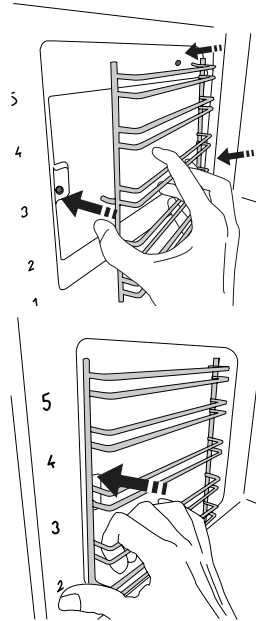

## REMOVING AND REINSTALLING THE SLIDING GUIDES

(Only in some models)

1. Remove the shelf guides.
2. Disengage the guide's anchoring clips from the shelf guide, starting from the lower part.

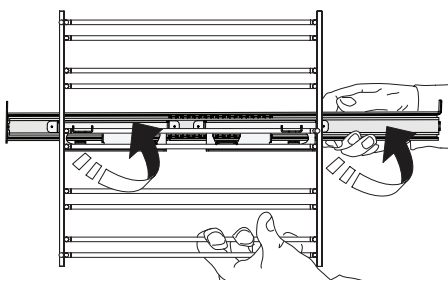

3. To reinstall the sliding guides, anchor the guide's upper clip to the shelf guide, then lower the other clip into position.

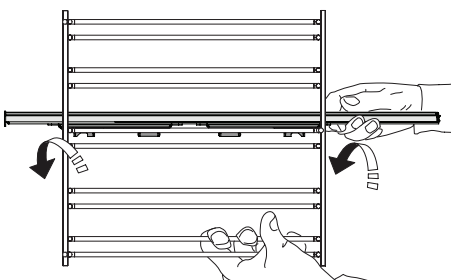

4. To secure the guide, press the lower portion of the clip firmly against the shelf guide. Make sure that the runners can move freely.

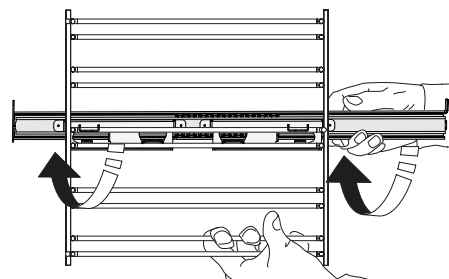

5. Reposition the shelf guides.

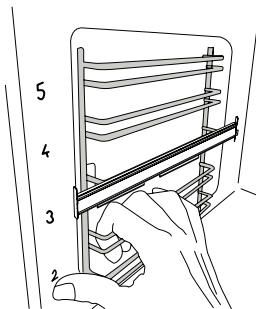



# FUNCTIONS

---

 **CONVENTIONAL**  
For cooking any kind of dish on one shelf only.

---

 **MULTILEVEL**  
For cooking different foods that require the same cooking temperature on several shelves (maximum three) at the same time. This function can be used to cook different foods without odours being transferred from one food to another.

---

 **XL COOKING**  
For cooking large joints of meat (above 2.5 kg). We recommend turning the meat over during cooking to ensure that both sides brown evenly. We also recommend basting the joint every so often to prevent it from drying out excessively.

---

 **PIZZA**  
For baking different types and sizes of pizza and bread. It is a good idea to swap the position of the baking trays halfway through cooking.

---

 **GRILL**  
For grilling steaks, kebabs and sausages, cooking vegetables au gratin or toasting bread. When grilling meat, we recommend using a Baking tray to collect the cooking juices: position the pan on any of the levels below the wire shelf and add 200 ml of drinking water.

---

 **GRATIN**  
For roasting large joints of meat (legs, roast beef, chicken). We recommend using a Baking tray to collect the cooking juices: position the pan on any of the levels below the wire shelf and add 200 ml of drinking water.



---

 **KEEP WARM**  
For helping sweet or savoury dough to rise effectively. To maintain the quality of proving, do not activate the function if the oven is still hot following a cooking cycle.

---

 **FREADY COOK**  
All the heating elements and the fan come on, guaranteeing the distribution of heat consistently and uniformly throughout the oven. Pre-heating is not necessary for this cooking mode. This mode is especially recommended for cooking pre-packed food quickly (frozen or pre-cooked). The best results are obtained if you use one cooking rack only.

---

 **ECO FORCED AIR**  
For cooking roasts and stuffed roasting joints on a single shelf. Food is prevented from drying out excessively by gentle, intermittent air circulation. When this ECO function is in use, the light will remain switched off during cooking but can be switched on again by pressing .

---

 **HYDROCLEANING**  
The action of the steam released during this special low-temperature cleaning cycle allows dirt and food residues to be removed with ease. Pour 200 ml of drinking water on the bottom of the oven and only activate the function when the oven is cold.

---



 **TURN & COOK**  
This function automatically selects an ideal temperature and time for baking a wide range of recipes including meat, fish, pasta, sweets and vegetables. Activate the function when the oven is cold.

---





# USING THE APPLIANCE FOR THE FIRST TIME

## 1. SETTING THE TIME

You will need to set the time when you switch on the appliance for the first time: Press  until the  icon and the two digits for the hour start flashing on the display.



Use + or - to set the hour and press  to confirm. The two digits for the minutes will start flashing. Use + 0 - to set the minutes and press  to confirm.

Please note: When the  icon is flashing, for example following lengthy power outages, you will need to reset the time.

## 2. HEAT THE OVEN

A new oven may release odours that have been left behind during manufacturing: this is completely normal.

Before starting to cook food, we therefore recommend heating the oven with it empty in order to remove any possible odours.

Remove any protective cardboard or transparent film from the oven and remove any accessories from inside it.

Heat the oven to 250 °C for about one hour.

The oven must be empty during this time. Follow the instructions for setting the function correctly.

Please note: It is advisable to air the room after using the appliance for the first time.

# DAILY USE

## 1. SELECT A FUNCTION

To select a function, turn the *selection knob* to the symbol for the function you require: the display will light up and an audible signal will sound.



## 2. ACTIVATE A FUNCTION

### MANUAL



To start the function you have selected, turn the *thermostat knob* to set the temperature you require.



Please note: During cooking you can change the function by turning the *selection knob* or adjust the temperature by turning the *thermostat knob*.

The function will not start if the *thermostat knob* is on 0 °C. You can set the cooking time, cooking end time (only if you set a cooking time) and a timer.

## TURN & COOK

To start the "Turn & Cook" function, select the function turning the *selection knob* on the relevant icon, keeping the *thermostat knob* on the  /  icon. To end the cooking, turn the *selection knob* on "0".

Please note: You can set the cooking end time and timer. To obtain the best cooking results using the "Turn & Cook" function, follow the suggested weights for each kind of food in the following table.



Food	Recipe	Weight (kg)
Meat	Roast veal, Roast Beef rare	0,6 - 0,7
	Chicken / Leg of lamb in pieces	1,0 - 1,2
Fish	Salmon fillet / Baked fish (whole)	0,9 - 1,0
	Fish en papillote	0,8 - 1,0
Vegetables	Stuffed vegetables	1,8 - 2,5
	Vegetable pie	1,5 - 2,5
Salty cakes	Quiche lorraine / Flan	1,0 - 1,5
Pasta	Lasagne / Timbale of pasta or rice	1,5 - 2,0
Pastry	Leavened cake / Plum cake	0,9 - 1,2
	Baked apples	1,0 - 1,5
Bread	Bread loaf	0,5 - 0,6
	Baguettes	0,5 - 0,8

## KEEP WARM

To start the "Keep Warm" function, turn the *thermostat knob* to the relevant symbol; if the oven is set to a different temperature (or if the cavity temperature is above 65°C) the function will not start.

Please note: You can set the cooking time, cooking end time (only if you set a cooking time) and a timer.

### 3. PREHEATING



Once the function starts, an audible signal and a flashing icon  on the display indicate that the preheating phase has been activated. At the end of this phase, an audible signal and the fixed icon  on the display will indicate that the oven has reached the set temperature: at this point, place the food inside and proceed with cooking.

Please note: Placing the food in the oven before preheating has finished may have an adverse effect on the final cooking result.

### . PROGRAMMING COOKING

You will need to select a function before you can start programming cooking.



#### DURATION

Keep pressing  until the  icon and "00:00" start flashing on the display.



Use  $+$  or  $-$  to set the cooking time you require, then press  to confirm.

Activate the function by turning the *thermostat knob* to the temperature you require: an audible signal will sound and the display will indicate that cooking is complete.

Notes: To cancel the cooking time you have set, keep pressing  until the  icon starts flashing on the display, then use  $-$  to reset the cooking time to "00:00". This cooking time includes a preheating phase.

#### PROGRAMMING THE END COOKING TIME/ DELAYED START

After a cooking time has been set, starting the function can be delayed by programming its end time: press  until the  icon and the current time start flashing on the display.



Use  $+$  or  $-$  to set the time you want cooking to end and press  to confirm.

Activate the function by turning the *thermostat knob* to the temperature you require: the function will remain paused until it starts automatically after the period of time that has been calculated in order for cooking to finish at the time you have set.

Notes: To cancel the setting, switch the oven off by turning the *selection knob* to the **0** position.

### END OF COOKING

An audible signal will sound and the display will indicate that the function has finished.

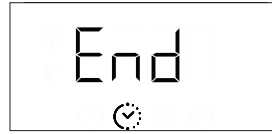



Turn the *selection knob* to select a different function or to position "0" to switch the oven off.

Please note: If the timer is active, the display will show "END" alternately with the remaining time.

### . SETTING THE TIMER

This option does not interrupt or program cooking but allows you to use the display as a timer, either during while a function is active or when the oven is off.

Keep pressing  until the  e "00:00" icon and "00:00" start flashing on the display.



Use  $+$  or  $-$  to set the time you require and press  to confirm.

An audible signal will sound once the timer has finished counting down the selected time.

Notes: To cancel the timer, keep pressing  until the  icon starts flashing, then use  $-$  to reset the time to "00:00".

### . HYDROCLEANING FUNCTION

To activate the "Hydrocleaning" cleaning function, pour 200 ml of drinking water into the bottom of the oven, then turn the *selection knob* and the *thermostat knob* to the icon .

Please note: The position of the icon does not correspond to the temperature reached during the cleaning cycle.

The function will activate automatically: the display shows the time remaining to the end, alternating with "HYD".

Please note: It is only possible to programme the end time of this function. The duration is automatically set to 35 minutes.

## USEFUL TIPS

### HOW TO READ THE COOKING TABLE

The table indicates the best function to use for any given food, to be cooked on one or more shelves at the same time. Cooking times start from the moment food is placed in the oven, excluding pre-heating (where required). Cooking temperatures and times are purely for guidance and will depend on the amount of food and type of accessory used. Use the lowest recommended settings to begin with and, if the food is not cooked enough, then switch to higher settings. Use the accessories supplied and preferably dark-coloured metal cake tins and baking trays. You can also use Pyrex pans and accessories or ones made from china, but bear in mind that cooking times will be slightly longer. For best results, follow the recommendations in the cooking table carefully when selecting which of the supplied accessories to place on which of the shelves.

### COOKING DIFFERENT FOODS AT THE SAME TIME

Using the "Multilevel" function, you can cook different foods which require the same cooking temperature at the same time (for example: fish and vegetables), using different shelves. Remove the food which requires a shorter cooking time and leave the food which requires a longer cooking time in the oven.

### DESSERTS

- Cook delicate desserts with the conventional function on one shelf only. Use dark-coloured metal baking pans and always place them on the wire shelf supplied. To cook on more than one shelf, select the "Multilevel" function and position the baking pans on different shelves to facilitate the circulation of hot air.
- Use dark-coloured metal baking pans and always place them on the wire shelf supplied.
- To check whether a leavened cake is cooked, insert a wooden toothpick into the centre of the cake. If the toothpick comes out clean, the cake is ready.
- If using non-stick cake tins, do not butter the edges as the cake may not rise evenly around the edges.
- If the item "swells" during baking, use a lower temperature next time and consider reducing the amount of liquid you add or stirring the mixture more gently.
- For sweets with moist fillings (cheesecake or fruit pies) use the "Multilevel" function. If the base of the cake is soggy, lower the shelf and sprinkle the bottom of the cake with breadcrumbs or biscuit crumbs before adding the filling.



































































### MEAT







- Use any kind of oven tray or pyrex dish suited to the size of the piece of meat being cooked. For roast joints, it is best to add some stock to the bottom of the dish, basting the meat during cooking for added flavour. Please note that steam will be generated during this operation. When the roast is ready, let it rest in the oven for another 10-15 minutes, or wrap it in aluminium foil.
- When grilling pieces of meat, choose cuts of the same thickness to obtain even cooking. Very thick pieces of meat require longer cooking times. To prevent the meat from burning on the outside, lower the position of the wire shelf, keeping the food farther away from the grill. Turn the meat two thirds of the way through cooking. Take care when opening the door as steam will escape. To collect the cooking juices, we recommend placing a dripping pan filled with 200 ml of drinking water directly underneath the wire shelf on which the food is placed. Top-up when necessary.





### PIZZA

Lightly grease the trays to ensure the pizza has a crispy base. Scatter the mozzarella over the pizza two thirds of the way through cooking.

# COOKING TABLE

RECIPE	FUNCTION	PREHEATING	TEMPERATURE (°C)	DURATION (MIN)	LEVEL AND ACCESSORIES
<b>Leavened cakes</b>		Yes	160 - 180	30 - 90	2/3 
		Yes	160 - 180	30 - 90	4 1  
<b>Filled cake</b> (cheese cake, strudel, fruit pie)		Yes	160 - 200	35 - 90	2 
		Yes	160 - 200	40 - 90	4 2  
<b>Biscuits/tartlets</b>		Yes	160 - 180	20 - 45	3 
		Yes	150 - 170	20 - 45	4 2  
		Yes	150 - 170	20 - 45	5 3 1   
<b>Choux buns</b>		Yes	180 - 210	30 - 40	3 
		Yes	180 - 200	35 - 45	4 2  
		Yes	180 - 200	35 - 45	5 3 1   
<b>Meringues</b>		Yes	90	150 - 200	3 
		Yes	90	140 - 200	4 2  
		Yes	90	140 - 200	5 3 1   
<b>Pizza/bread</b>		Yes	190 - 250	15 - 50	1 / 2 
		Yes	190 - 250	20 - 50	4 2  
<b>Frozen pizza</b>		Yes	250	10 - 20	3 
		Yes	230 - 250	10 - 25	4 2  
<b>Salty cakes</b> (vegetable pie, quiche)		Yes	180 - 200	40 - 55	3 
		Yes	180 - 200	45 - 60	4 2  
		Yes	180 - 200	45 - 60	5 3 1   
<b>Vols-au-vents/ puff pastry crackers</b>		-	190 - 200	20 - 30	3 
		-	180 - 190	20 - 40	4 2  
		-	180 - 190	20 - 40	5 3 1   
<b>Lasagne/baked pasta/ canneloni/flans</b>		Yes	190 - 200	45 - 65	2 

FUNCTIONS							
	Conventional	Grill	Gratin	Pizza	Multilevel	XL cooking	Eco Multilevel

ACCESSORIES					
	Wire shelf	Baking dish or cake tin on the wire shelf	Baking tray/Drip tray or Baking dish on the wire shelf	Drip tray / Baking tray	Drip tray / Baking tray with 200 ml of water

RECIPE	FUNCTION	PREHEATING	TEMPERATURE (°C)	DURATION (MIN)	LEVEL AND ACCESSORIES
Lamb/veal/beef/pork 1 kg		Yes	190 - 200	80 - 110	3
Roast pork with crackling 2 kg		Yes	180 - 190	110 - 150	2
Chicken/rabbit/duck 1 kg		Yes	200 - 230	50 - 100	2
Turkey/goose 3 kg		-	190 - 200	100 - 160	2
Baked fish/en papillote (fillets, whole)		Yes	170 - 190	30 - 50	2
Stuffed vegetables (tomatoes, courgettes, aubergines)		Yes	180 - 200	50 - 70	2
Toasted bread		-	250	2 - 6	5
Fish fillets/slices		-	230 - 250	20 - 30*	4  3
Sausages/kebabs/spare ribs/hamburgers		-	250	15 - 30*	5  4
Roast chicken 1-1.3 kg		Yes	200 - 220	55 - 70**	2  1
Roast beef rare 1 kg		Yes	200 - 210	35 - 50**	3
Leg of lamb/knuckle		Yes	200 - 210	60 - 90**	3
Roast potatoes		Yes	200 - 210	35 - 55**	3
Vegetable gratin		-	200 - 210	25 - 55	3
Meat and potatoes		Yes	190 - 200	45 - 100***	4  1
Fish and vegetables		Yes	180	30 - 50***	4  1
Lasagne and meat		Yes	200	50 - 100***	4  1
Complete meal: fruit tart (level 5) / lasagne (level 3) / meat (level 1)		Yes	180 - 190	40 - 120***	5  3  1
Roast meat/stuffed roasting joints		-	170 - 180	100 - 150	2

The time indicated does not include the preheating phase: we recommend placing the food in the oven and setting the cooking time only after the required temperature has been reached.

\* Turn food halfway through cooking.















\*\* Turn food two thirds of the way through cooking (if necessary).

\*\*\* Estimated length of time: dishes can be removed from the oven at different times depending on personal preference.

FUNCTIONS							
	Conventional	Grill	Gratin	Pizza	Multilevel	XL cooking	Eco Multilevel
ACCESSORIES							
	Wire shelf	Baking dish or cake tin on the wire shelf	Baking tray/Drip tray or Baking dish on the wire shelf	Drip tray / Baking tray	Drip tray / Baking tray	Drip tray / Baking tray with 200 ml of water	Drip tray / Baking tray with 200 ml of water

# TESTED RECIPES







Compiled for the certification authorities in accordance with the standard IEC 60350-1

RECIPE	FUNCTION	PRE REHEAT	LEV	TEMP. (°C)	DURATION (MIN)	ACCESSORIES* AND NOTES
Shortbread		Yes	3	150	30 - 40	Drip tray/baking tray
		Yes	3	150	45 - 55	Drip tray/baking tray
		Yes	2 - 4	150	35 - 45	Shelf 4: baking tray Shelf 2: drip tray / baking tray
		Yes	1 - 3 - 5	150	40 - 50	Shelf 5: baking tray / oven tray on wire shelf Shelf 3: baking tray Shelf 1: drip tray/baking tray
Small cakes		Yes	3	160	25 - 35	Drip tray/baking tray
		Yes	3	160	25 - 35	Drip tray/baking tray
		Yes	2 - 4	150	35 - 45	Shelf 4: baking tray Shelf 2: drip tray / baking tray
Fatless sponge cake		Yes	3	170	35 - 45	Cake tin on wire shelf
		Yes	2	160	35 - 45	Cake tin on wire shelf
		Yes	1 - 4	160	45 - 55	Shelf 4: cake tin on rack Shelf 1: Baking pan on wire shelf
2 Apples pies		-	2	185	70 - 90	Cake tin on wire shelf
		-	2	175	70 - 90	Cake tin on wire shelf
		-	1 - 4	175	75 - 95	Shelf 4: baking pan on wire shelf Shelf 1: cake tin on rack
Toast		5 min	5	250	2 - 5	Wire shelf
Burgers		5 min	5	250	18 - 30	Shelf 5: rack (turn food halfway through cooking)
						Shelf 4: drip tray with water

\* You can obtain any accessories that are not supplied from our After-sales service.

The guidelines in the table are not intended for use with the sliding runners. You will need to test different temperatures and cooking times, etc. without the sliding runners.

**Energy efficiency class (in accordance with the IEC 60350-1 standard):** Refer to the specific table to conduct the test.

FUNCTIONS							
	Conventional	Grill	Gratin	Pizza	Multilevel	XL cooking	Eco Multilevel



# CLEANING

**Do not use steam cleaning equipment.**

**Use protective gloves during all operations.**

**Carry out the required operations with the oven cold.**

**Disconnect the appliance from the power supply.**

**Do not use wire wool, abrasive scourers or abrasive/corrosive cleaning agents, as these could damage the surfaces of the appliance.**

## EXTERIOR SURFACES

- Clean the surfaces with a damp microfibre cloth. If they are very dirty, add a few drops of pH-neutral detergent. Finish off with a dry cloth.
- Do not use corrosive or abrasive detergents. If any of these products inadvertently comes into contact with the surfaces of the appliance, clean immediately with a damp microfibre cloth.

## INTERIOR SURFACES

- After every use, leave the oven to cool and then clean it, preferably while it is still warm, to remove any deposits or stains caused by food residues. To dry any condensation that has formed as a result of cooking foods with a high water content, leave the oven to cool completely and then wipe it with a cloth or sponge.

- Activate the "Hydrocleaning" function for optimum cleaning of the internal surfaces.
- The door can be easily removed and refitted to facilitate cleaning of the glass.
- Clean the glass in the door with a suitable liquid detergent.
- The top heating element of the grill can be lowered to clean the upper panel of the oven.

## ACCESSORIES

- Soak the accessories in a washing-up liquid solution after use, handling them with oven gloves if they are still hot. Food residues can be removed using a washing-up brush or a sponge.



# MAINTENANCE

Use protective gloves during all operations.

Carry out the required operations with the oven cold.

Disconnect the oven from the power supply.

## REMOVING THE DOOR

1. Open the door fully.

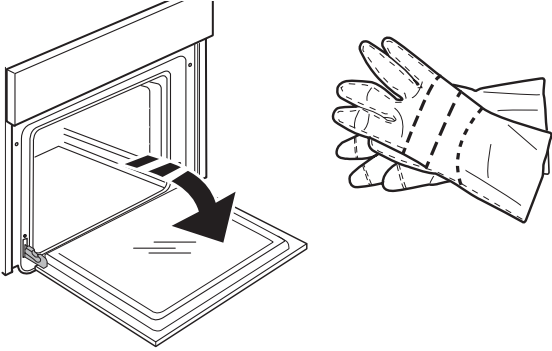

2. Lower the catches as far as possible.

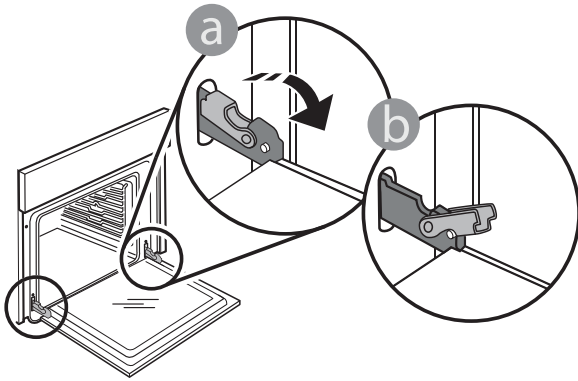

3. Close the door as much as you can.

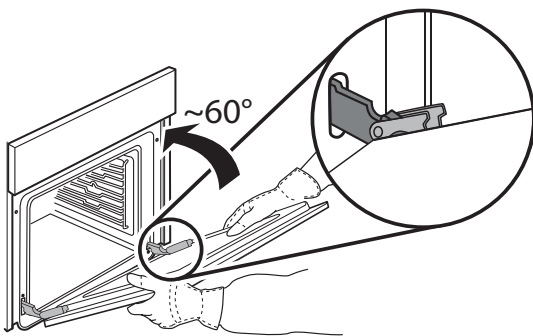

4. Take a firm hold of the door with both hands – do not hold it by the handle. Simply remove the door by continuing to close it while pulling it upwards at the same time until it is released from its seating.

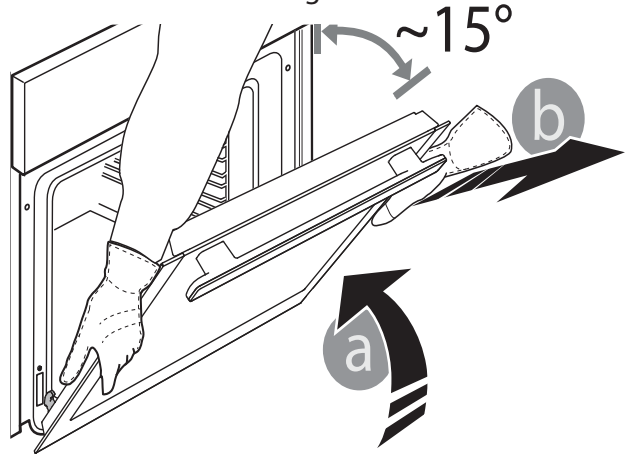

5. Put the door to one side, resting it on a soft surface.

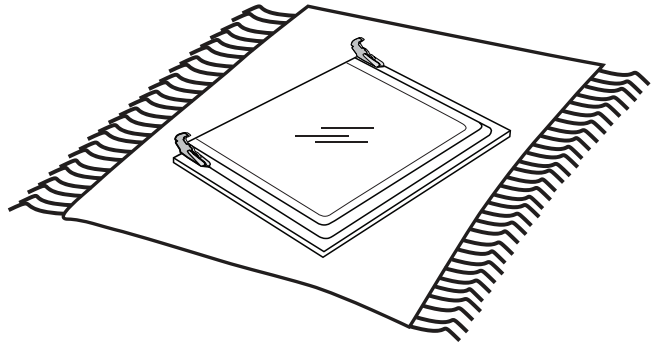

# REFITTING THE DOOR

**1.** Move the door towards the oven, aligning the hooks of the hinges with their seating.

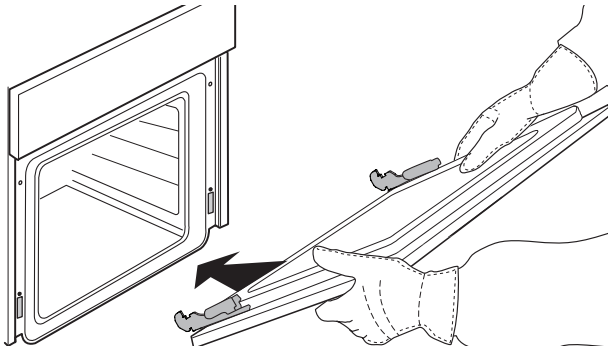

**2.** Secure the upper part into its seating.

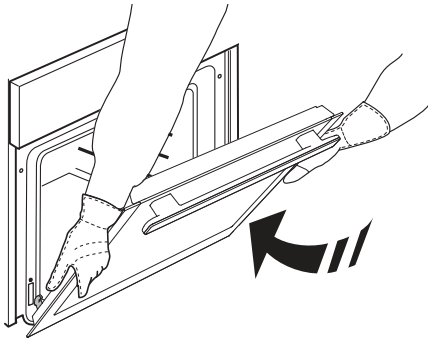

**3.** Lower the door and then open it fully.

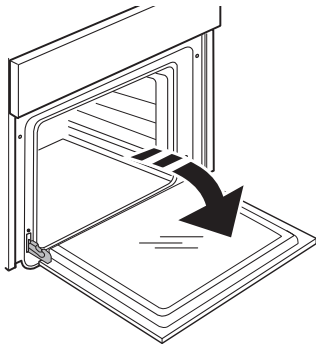

**4.** Lower the catches into their original position: Make sure that you lower them down completely.

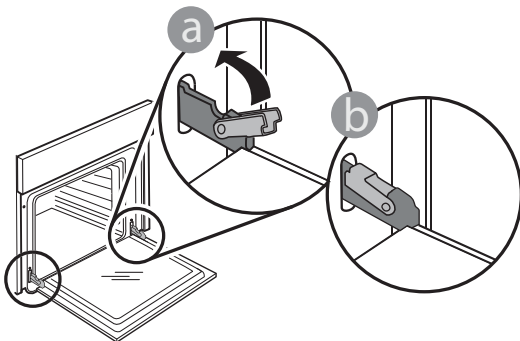

**5.** Try closing the door and check to make sure that it lines up with the control panel. If it does not, repeat the steps above: The door could become damaged if it does not work properly.

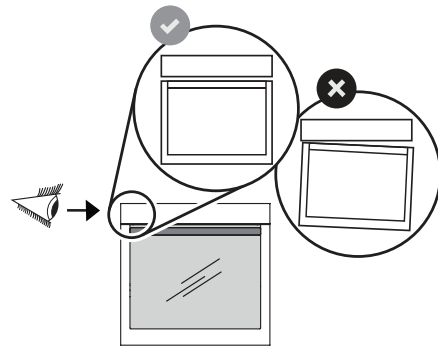
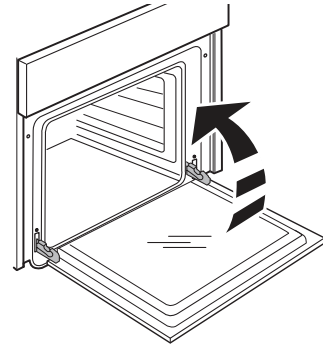

# CLICK & CLEAN - CLEANING THE GLASS

**1.** After removing the door and resting it on a soft surface with the handle downwards, simultaneously press the two retaining clips and remove the upper edge of the door by pulling it towards you.

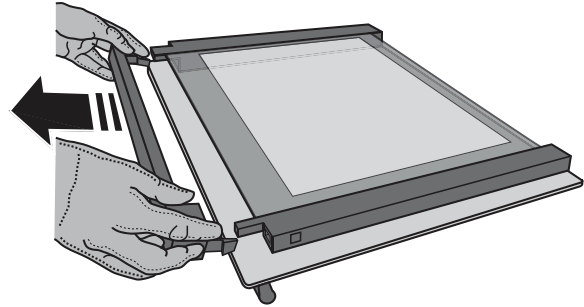
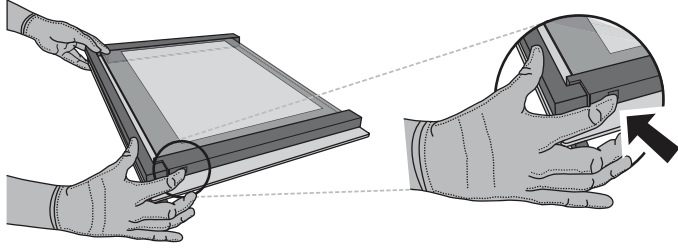

**2.** Lift and firmly hold the inner glass with both hands, remove it and place it on a soft surface before cleaning it.

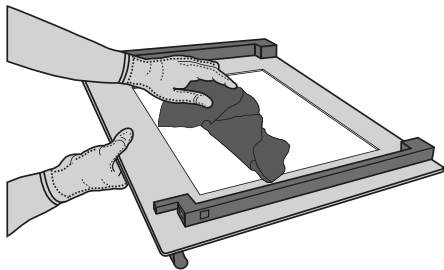
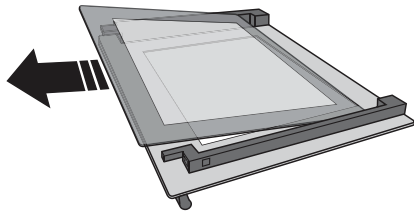

**3.** To correctly reposition the inner glass, make sure that the "R" is visible in the right-hand corner and the clear surface (not printed) is facing up. First insert the long side of the glass indicated by "R" into the support seats, then lower it into position.

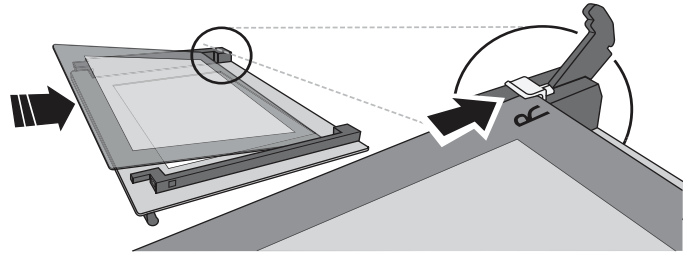

**4.** Refit the upper edge: A click will indicate correct positioning. Make sure the seal is secure before refitting the door.

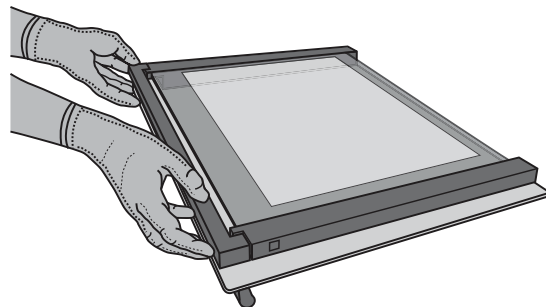
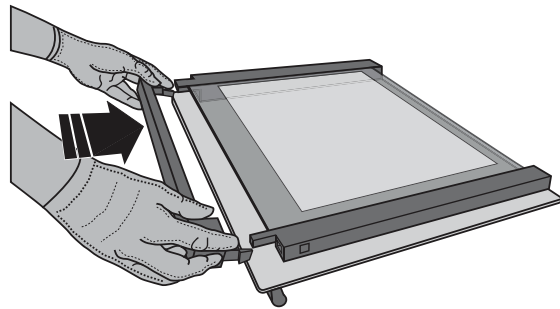

## REPLACING THE LIGHT

1. Disconnect the oven from the power supply.
2. Unscrew the cover from the light, replace the bulb and screw the cover back on the light.

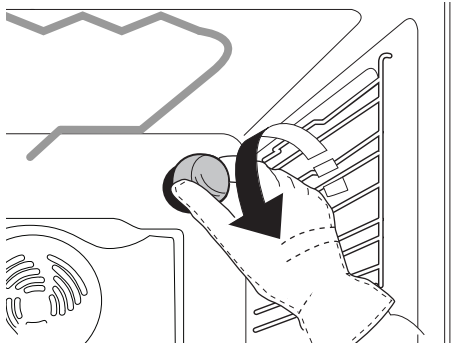

3. Reconnect the oven to the power supply.

Please note: Use 25 W/230 V type G9, T300 °C halogen lamps.

The bulb used in the product is specifically designed for domestic appliances and is not suitable for general room lighting within the home (EC Regulation 244/2009).

Light bulbs are available from our After-sales Service.

- Do not handle bulbs with your bare hands as your fingerprints could damage them. Do not use the oven until the light cover has been refitted.

## LOWERING THE UPPER HEATING ELEMENT (Only in some models)

1. Remove the heating element from its seating.

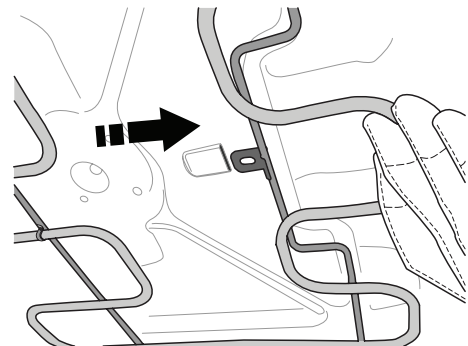

2. Lower the heating element.

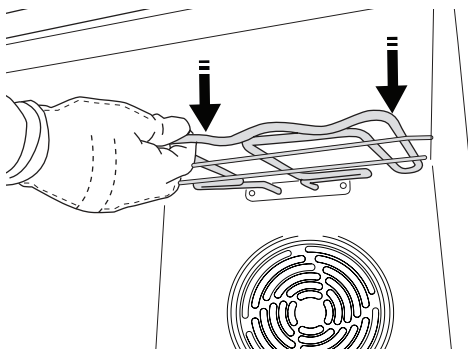

3. To return the heating element to its position, lift it up, pull it slightly towards you and make sure that the tab support is in its proper seating.

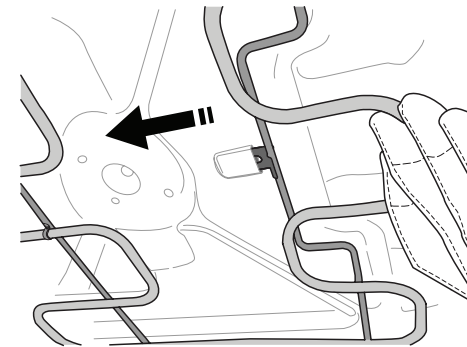

# TROUBLESHOOTING

Any problems or malfunctions that may occur can often be easily resolved.

Before contacting the After-sales Service, check the following table to see whether you can resolve the problem yourself.

If the problem persists, contact your nearest After-sales Service Centre.



**Read the safety instructions carefully before carrying out any of the following work**

PROBLEM	POSSIBLE CAUSE	REMEDY
The oven is not working.	Disconnection from the mains electricity. Fault.	Make sure that the oven is connected to the main electricity supply. Turn off the oven and restart it to see if the fault persists.
The display is showing the message "Hot" and the selected function will not start.	Temperature too high.	Allow the oven to cool down before activating the function. Select a different function.
Cooking will not start.	Temperature not set/ <i>thermostat knob</i> in the wrong position.	Turn the <i>thermostat knob</i> to the temperature or the position you require to activate the function you have selected.
The time is flashing.	Power cut.	You need to reset the time: Follow the instructions given in the "Using the appliance for the first time" section.
The display shows the letter "F" followed by a number.	Software fault.	Contact your nearest Client After-sales Service Centre and state the number following the letter "F".
The light is not working.	Oven OFF. Bulb gone.	Turn the <i>selection knob</i> to select a function and switch on the oven. If the fault persists, follow the instructions for replacing the bulb given in the "Maintenance" section.

# PRODUCT FICHE

 The product fiche with energy data of this appliance can be downloaded from the website [docs.indesit.eu](http://docs.indesit.eu)

## AFTER-SALES SERVICE

### BEFORE CONTACTING OUR AFTER-SALES SERVICE

**1.** Check whether you can resolve the problem yourself using any of the measures described in the "Troubleshooting" section.

**2.** Turn off the oven and restart it to see if the fault persists.

**IF THE PROBLEM PERSISTS AFTER HAVING PERFORMED ALL OF THE NECESSARY CHECKS, CONTACT YOUR NEAREST AFTER-SALES SERVICE CENTRE.**

To receive assistance, call the number given on the warranty leaflet enclosed with the product or follow the instructions on our website. Be prepared to provide:

- A brief description of the fault
- The exact type of model of your product
- The assistance code (the number following the word SERVICE on the identification plate attached to the product; this can be seen on the left-hand edge of the cooking compartment when the oven door is open).
- Your full address
- A contact telephone number

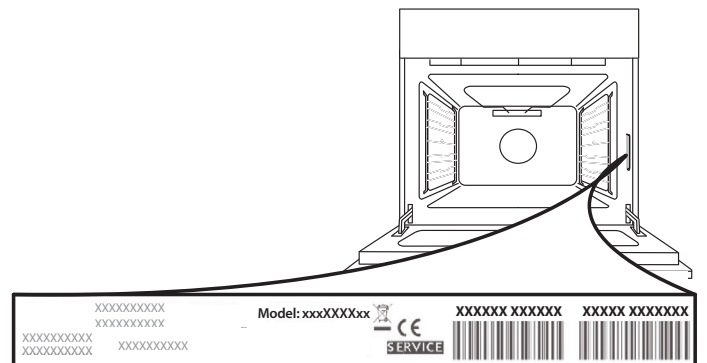

Please note: If repairs are required, contact an authorised service centre that is guaranteed to use original spare parts and perform repairs correctly.

Please refer to the enclosed warranty leaflet for more information on the warranty.

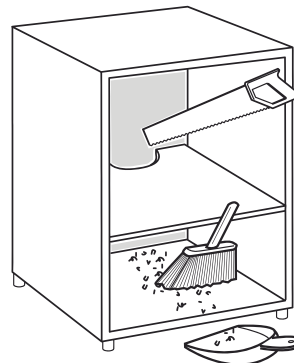
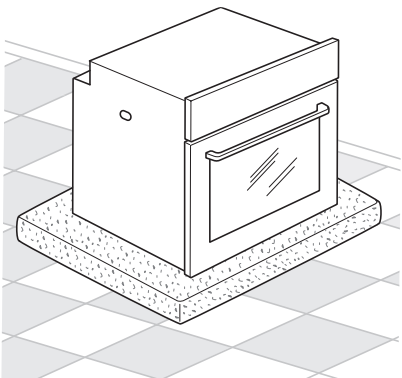
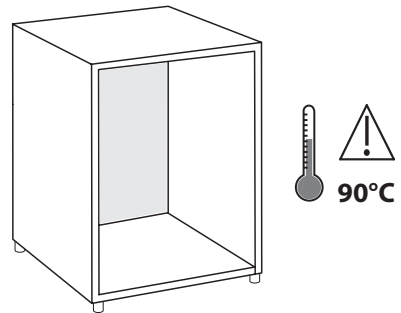
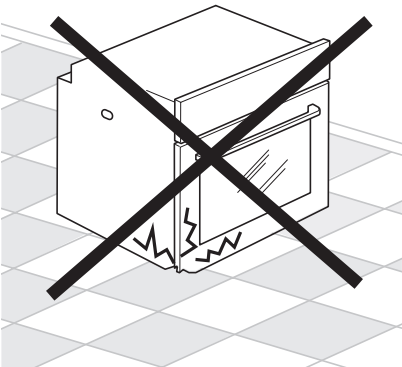
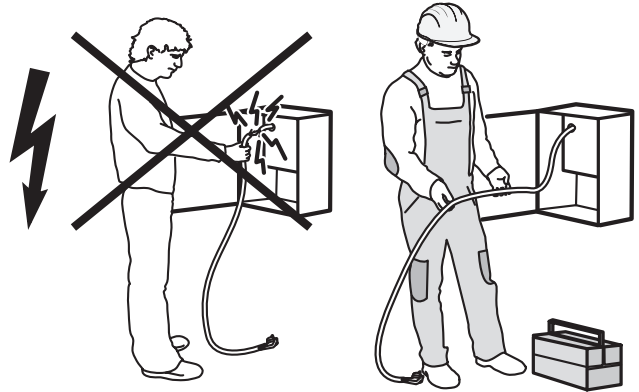
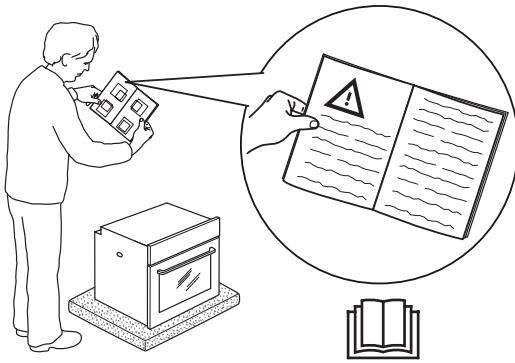
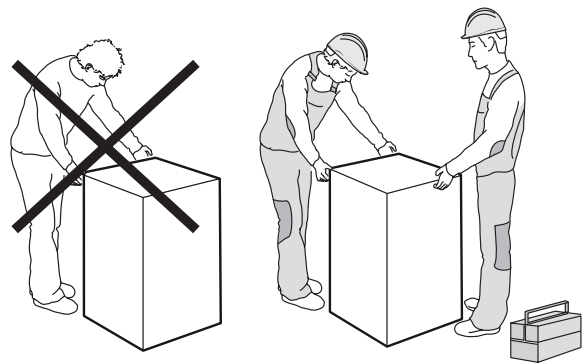
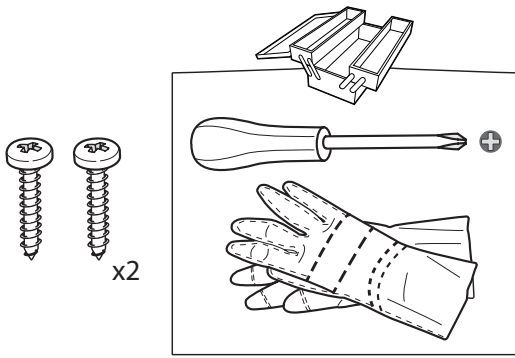



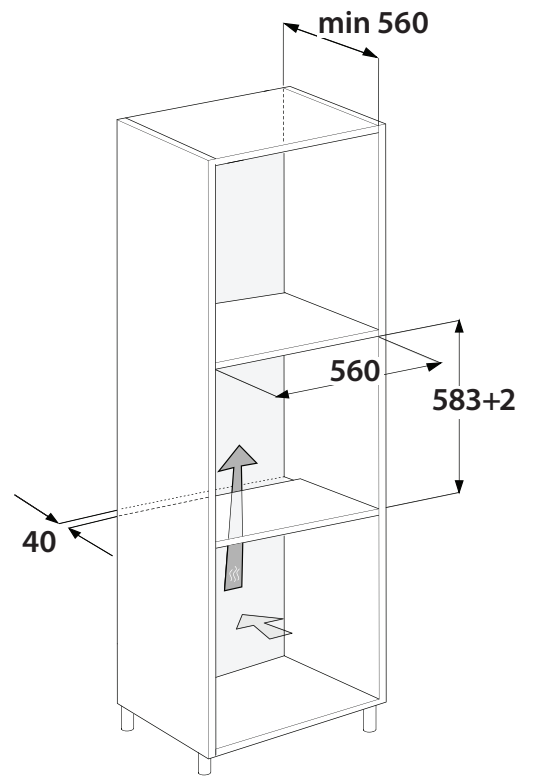
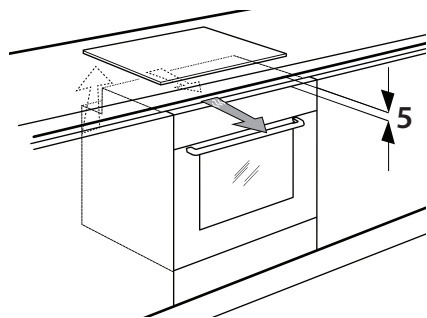
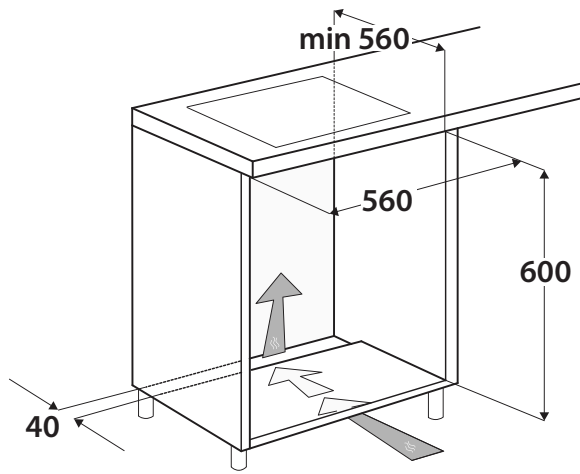
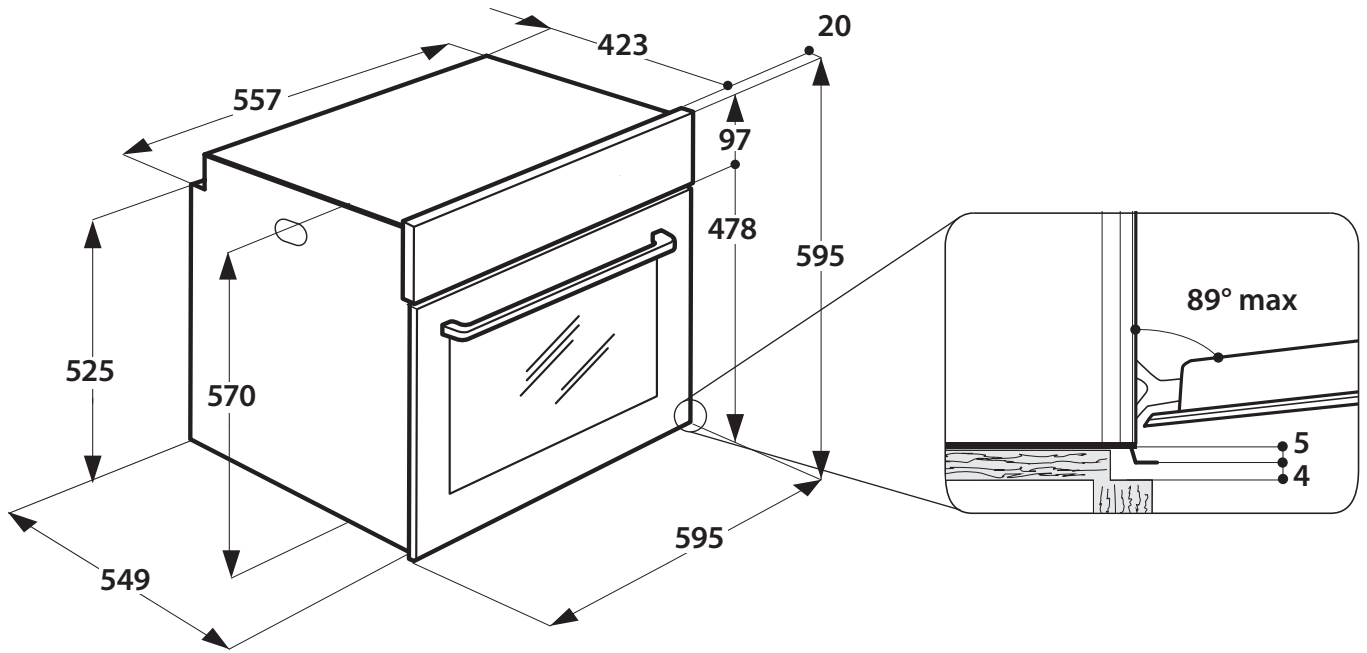

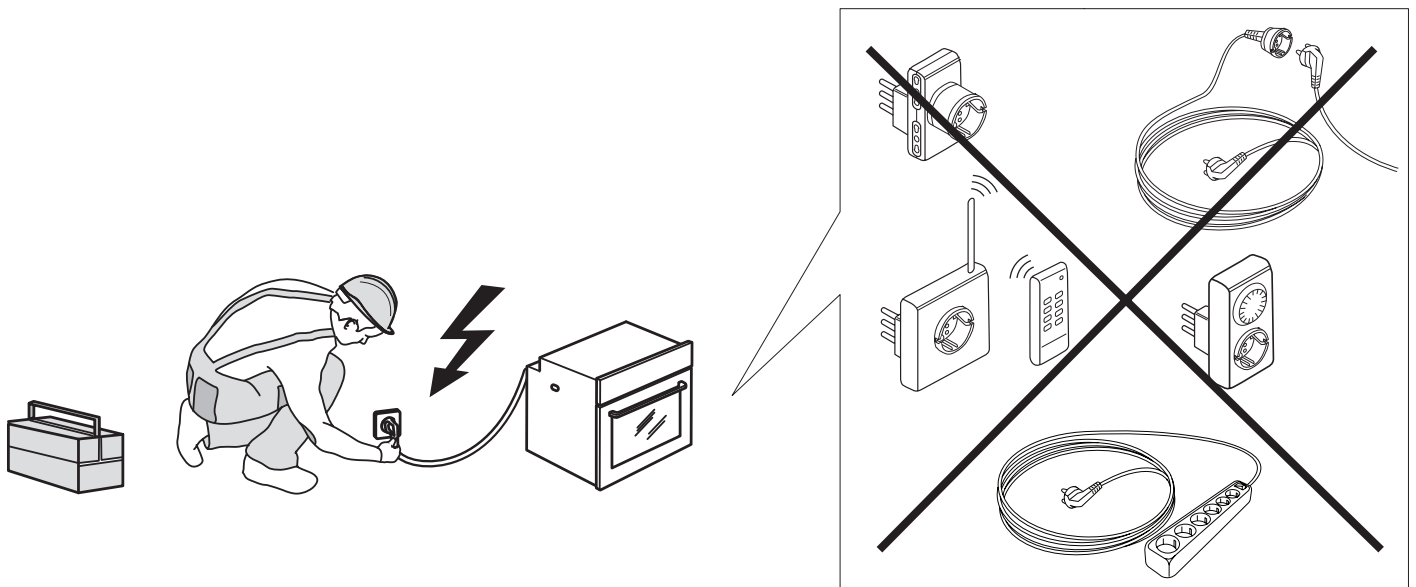
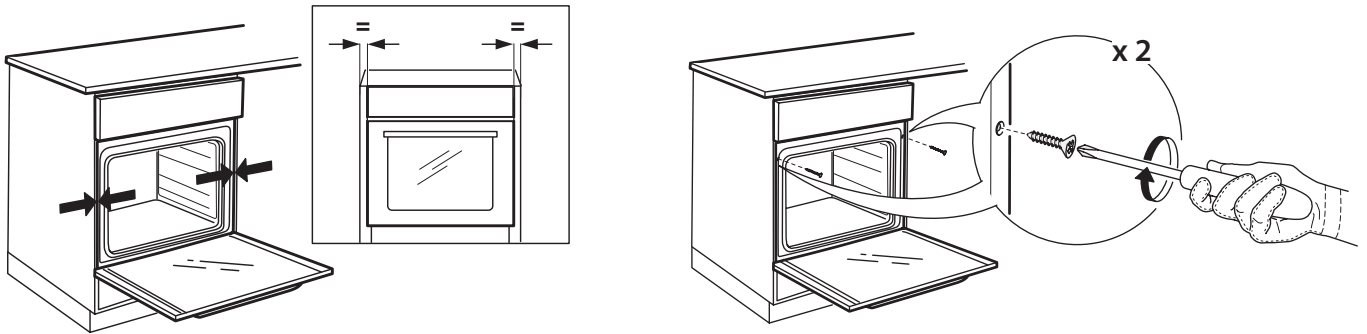
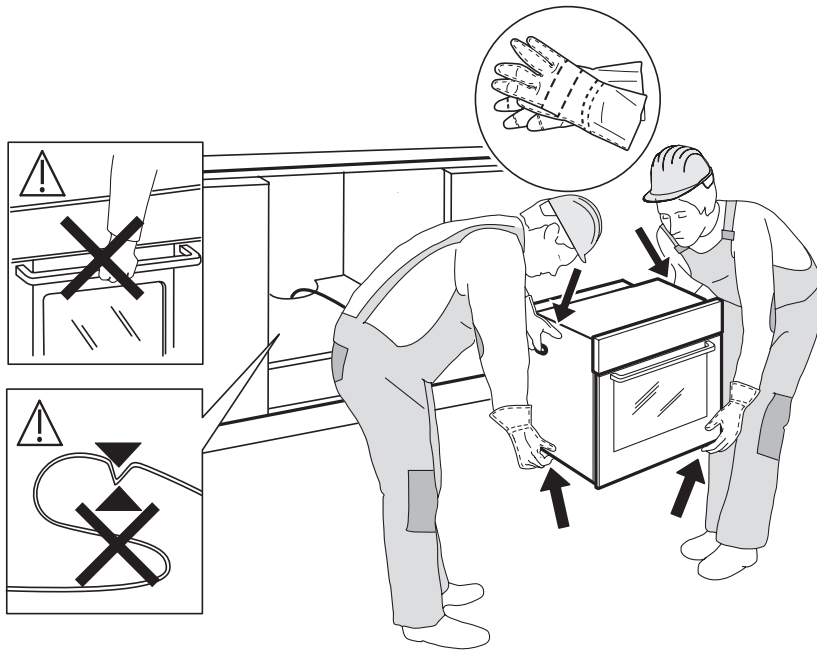

400011130977