

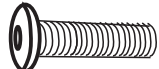





ASSEMBLY INSTRUCTIONS

A		 M6x25mm	8 pcs
B		 M6x45mm	1 pcs
C		 M6x65mm	4 pcs
D			1 pc

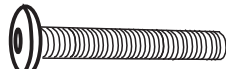
1

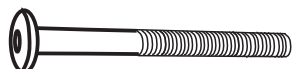

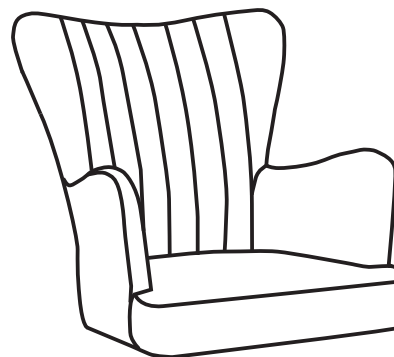
2

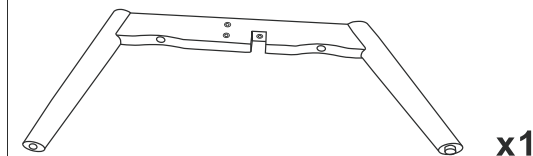
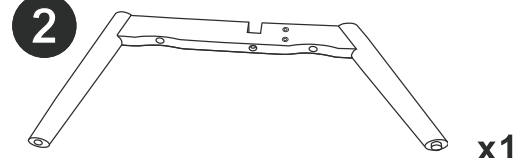

3

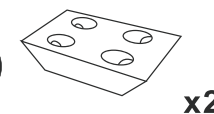

x2

4

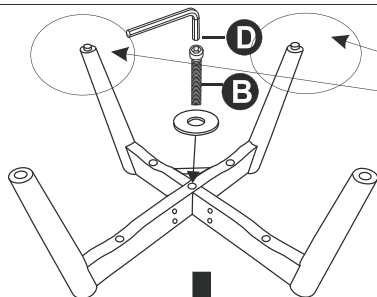

Σφίξτε τις βίδες αλλά όχι πολύ σφιχτά, 90% είναι εντάξει.
Tight the screws, but not too tight, 90% is ok.

5

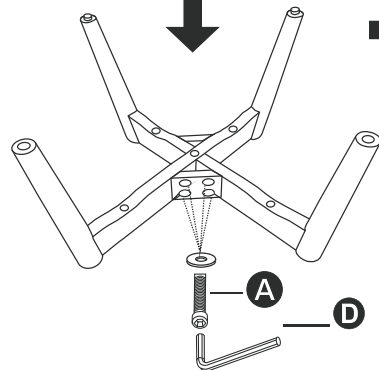

6

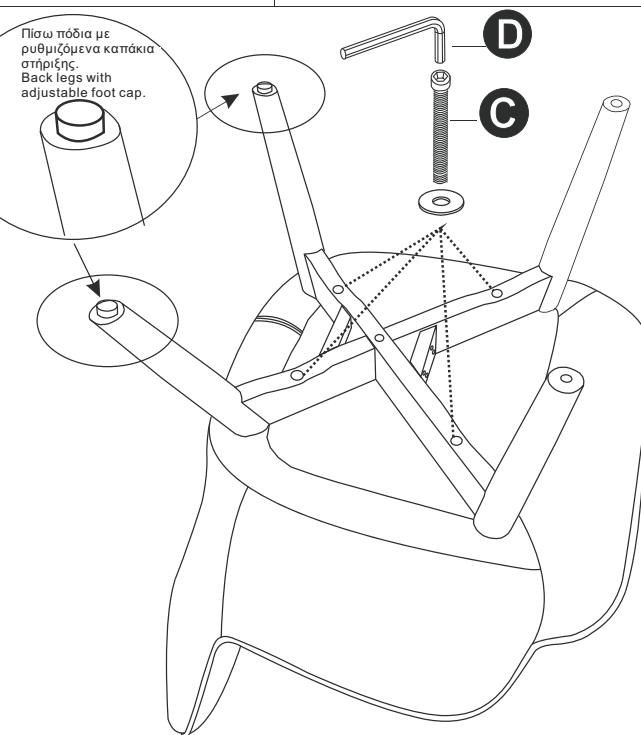

Πίσω πόδια με ρυθμιζόμενα καπάκια στήριξης.
Back legs with adjustable foot cap.

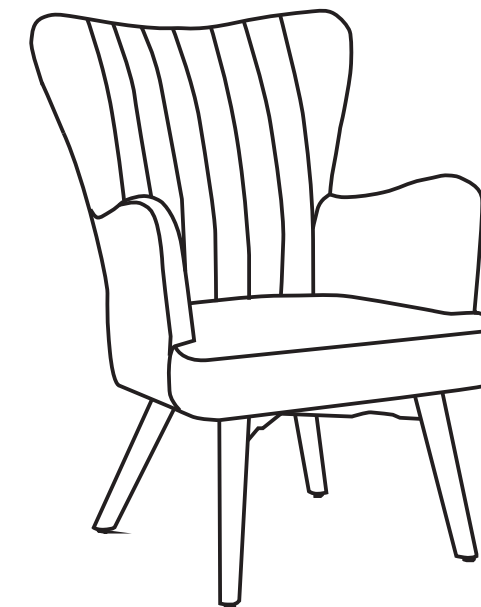

Σφίξτε όλες τις βίδες στο 100%.
Tight all the screws to 100%.