

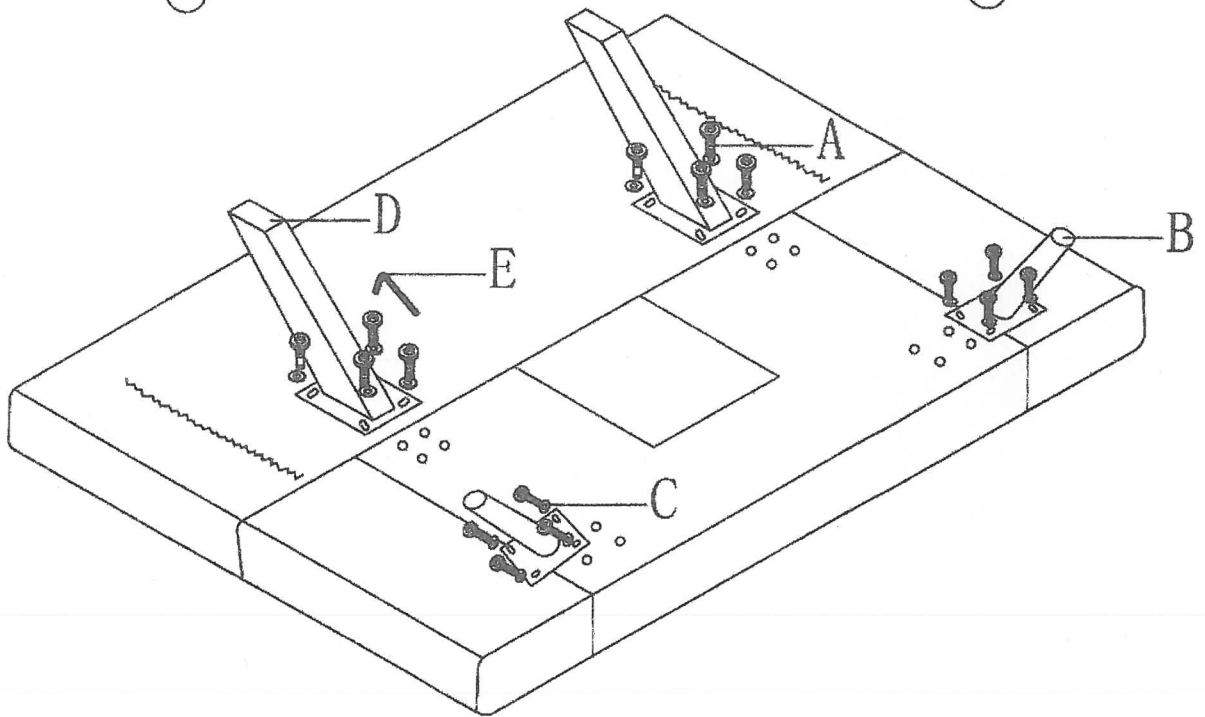

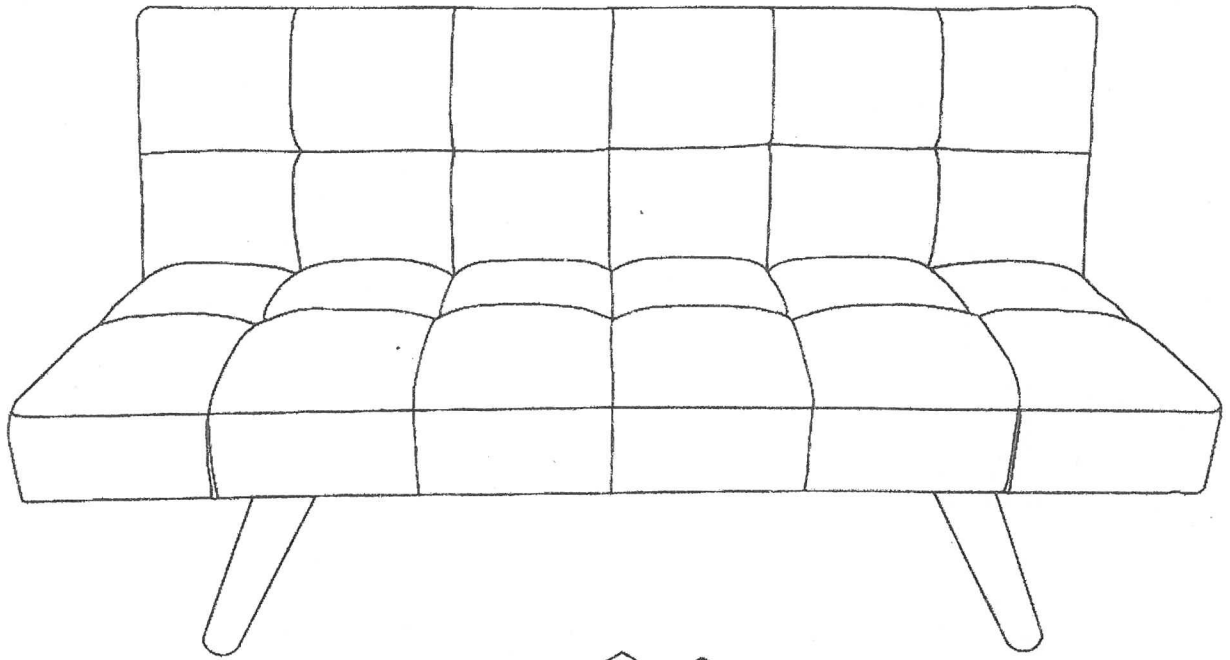



# QLM-W58B-2 (024-000005)



A 	B 	C 	D 	E 
16pcs	2pcs	16pcs	2pcs	1pcs
M8x10	—	M8	—	M5