

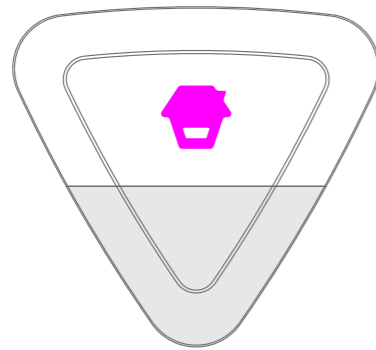

Wireless Outdoor Strobe Siren

WS-280

User Manual



Introduction

Wireless outdoor strobe siren is to deter the intruders through hooting once it receives wireless signal from connected control panel or sensors. More wireless strobe sirens could be connected to the same control panel to strengthen the deterrent effect. When the siren is connected to control panel as an accessory, it will hoot and its LED lights will flash once the system is triggered. When the siren is connected to sensors like remote control, door/window contact, and PIR motion detector, etc. as an standalone alarm control panel, it will hoot and its LED lights flash once any sensor is triggered.

Product Overview

Front View

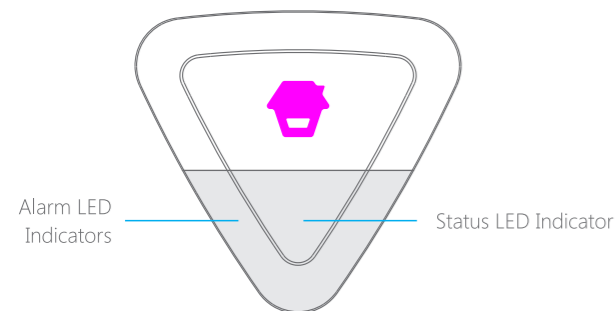

Status LED Indication

Status	LED
Arm/Home Mode	Flash once every 5 seconds
Disarm	No light indication
No disarm operation after alarm	Flash once every 2 seconds for 2 hours

Rear View

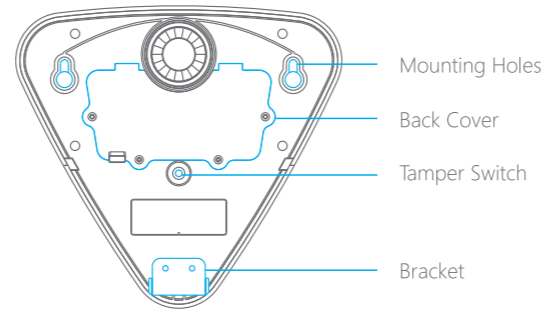

PCB Layout

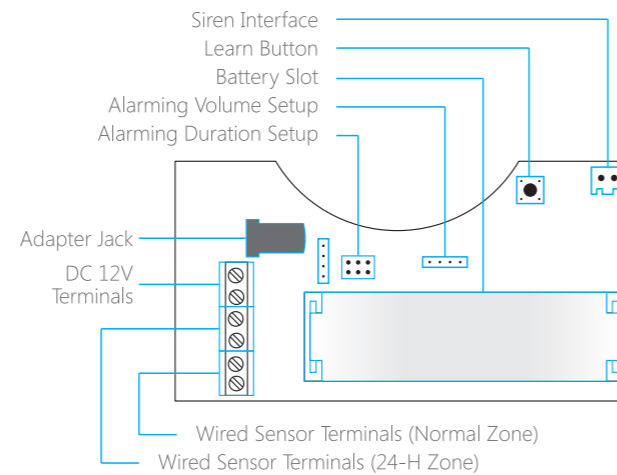

Jumper Setup

Please setup alarming volume and alarming duration time on the PCB board accordingly.

Alarming Volume Setup

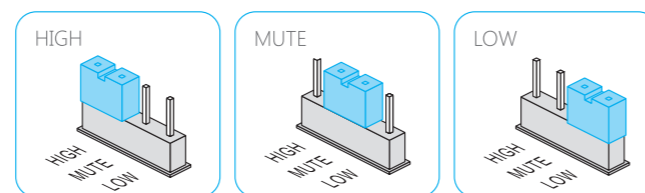

Default Setting

Note: When the siren is connected to control panel, it will hoot at the pre-set volume even if the control panel is set to mute alarm. This is to alert the neighbors and avoid the intrusion. When the control panel is set to mute disarm/arm, the siren will be disarmed/ armed mutely. When the siren is set to mute mode, there are still tones for arming and disarming.

Alarming Duration Setup

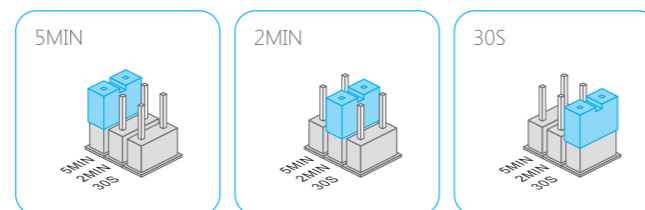

Default Setting

Work as Wireless Siren

When it works as a wireless siren, it should be connected with wireless control panel in advance. When the control panel is alarming, it hoots and the strobe light flashes to deter illegal intruders.

Connect to Control Panel

Press the Learn button for 0.5 second, siren beeps once and enter connection status. Press [SOS] or [Arm] on the panel (or press Arm on App if the panel does not have a button), the wireless siren and control panel are connected successfully after one beep is heard from siren.

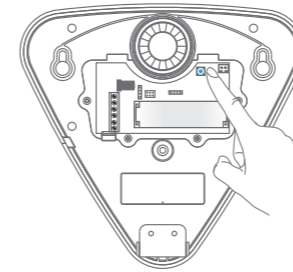

Note: Once the siren is in connection status, please press Learn button again to exit. One beep will be heard from siren. When connecting to control panel, please don't trigger any other sensors to avoid interference.

Disconnection

Hold the Learn button till 2 beeps are heard to disconnect the siren and control panel.

Work as Standalone Alarm Panel

When it works as a standalone alarm panel, it should be connected with wireless sensors or wired sensors in advance, when the intrusion is detected, it hoots and the strobe light flashed to deter illegal intruders.

Wired Terminals

The siren has terminals for power supply and wired sensors. Just connect the power line or wired sensors to the hardwired terminals. Please make sure the positive and negative are distinguished.

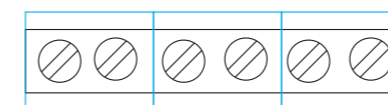

-DC12V+ 24-ZONE ZONE

Power: DC 12V Input

Zone(normal zone mode): Once the sensor in normal zone mode is triggered, the system will alarm immediately.

24-Zone(24-H zone mode): Once the sensor in 24-H zone mode is triggered, the system will alarm immediately, no matter what circumstances the system is in. Smoke detector, gas detector, and IR beams are strongly recommended to set in 24-H zone mode.

Connection & Disconnection

Maximum 40 sensors can be connected to the wireless strobe siren.

Connect with Remote Control

Press Learn button for 0.5 second till a beep is heard, the siren enters connection status.

Press any button in the remote control, the connection succeeds when a beep is heard from siren.

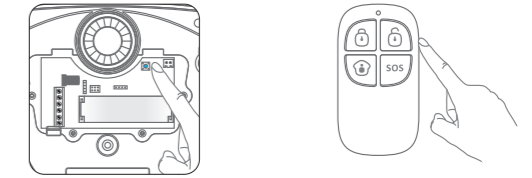

Connect with Door Window Contact

Put the door window contact transmitter and magnet close in right position.

Press Learn button for 0.5 second till a beep is heard, the siren enters connection status. Separate the magnet from the transmitter over 2 cm, the connection succeeds when a beep is heard from siren.

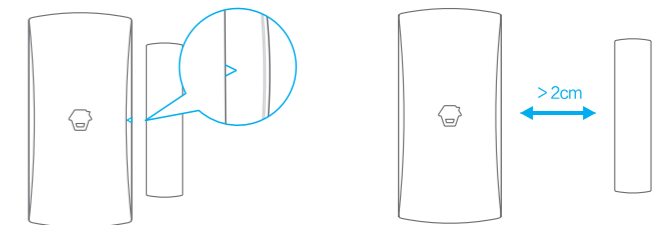

Connect with PIR Motion Detector

Press Learn button for 0.5 second till a beep is heard, the siren enters connection status.

Press test button at back of the detector twice continuously, the connection succeeds when a beep is heard from siren.

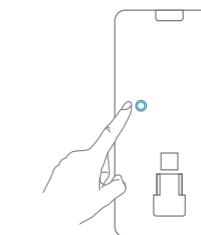

Connect with Other Accessories

Connect with other accessories is the same operation; please see details in the user manuals for accessories.

Note: Once the siren is in connection status, please press Learn button again to exit. (A beep will be heard from siren) When 2 beeps are heard in connection status, means the sensor has been connected before.

Disconnection

Hold the Learn button in the siren till 2 beeps are heard to disconnect the accessories from siren.

Installation Mode

Installation Mode is set for users to dismount or remount the siren without triggering the tamper switch. Thus not to disturb other people.

Press [Disarm ] button on the remote control continuously for 3 times, then the siren comes to installation mode after a long beep is heard. Any sensor or tamper triggered during installation mode will not result in siren hooting but 3 beeps will be heard instead.

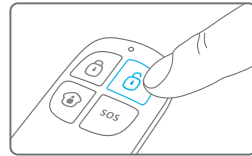

Press [Arm ] button, the siren will exit from installation mode after a long beep is heard. Or the siren will automatically exit from installation mode when no operation is carried out within 10 minutes.

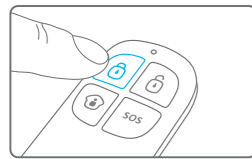

Note: Also you can press the tamper switch 7 times to enter service mode.

Installation

Please finish all the system setup on the PCB and enter into installation mode before installation.

- 1 Hold the positioning paper in right place, stick the gradienter on the positioning paper to check and adjust the position.
- 2 Install two screws into the top screw holes.
- 3 Mount the bracket into the bottom screw holes and tighten with screws.
- 4 Tear off the positioning paper.
- 5 Mount the siren to the wall, tighten the screw and make sure the siren is well positioned.

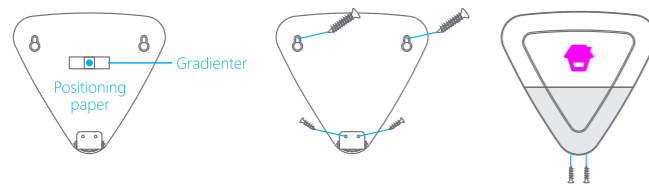

Remote Control Operation

Work as a standalone alarm panel, user can use remote control to arm, disarm, and mute arm or disarm the siren. SOS emergency call can be realized.

Arm



Press [Arm ] on the remote control, the status LED indicator in the wireless control flashes once to enter armed status and flashes once every 5 seconds later.

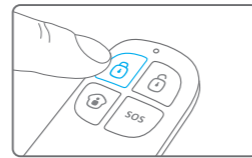

Disarm



Press [Disarm ] on the remote control, the status LED indicator in the wireless control flashes twice and then goes out to enter disarmed status.

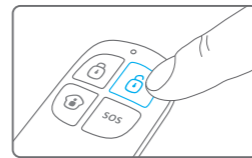

Home Arm (Part Arm)



When the system enters home armed status, all the sensors in normal zone is armed except those in home mode zone. While the home mode sensors are in disarmed status, users can move freely within the range of the disarmed area.

Press [Home Arm ] on the remote control, the status LED indicator in the wireless control flashes once to enter home armed status, and flashes once every 5 seconds later.

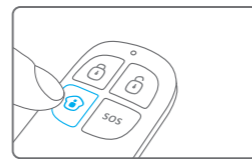

Note: The default zone setting of the PIR motion detector is home mode zone. When users press [Home Arm ], the PIR motion detector enters disarmed status.

Emergency Call



Whenever you press the [SOS] on the remote control, the system will alarm immediately and the alarm LED indicator will flash as well. After hooting without disarming the system, the status LED indicator will flash once every 2 seconds.



Enter Connection Status Through Remote Control

This function is set for users to connect newly-purchased accessories without dismantling the siren from the wall.

When the siren is in installation mode, press [Home Arm ] on the remote control continuously for 3 times, then the siren comes to connection status after a long beep is heard. The siren will exit from connection status when no operation is carried out in 15 seconds.

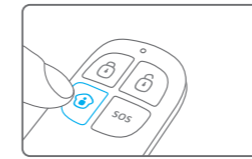

Zone Setting For Wireless Accessories

The zone setting is set through the inner jumpers of the sensors. If the zone setting is changed, the accessories need to be reconnected with the control panel.

The accessory can be set in normal zone, home mode zone or 24-H zone.

Normal Zone: In arm or home mode status, the system will alarm immediately once the sensors in normal zone is triggered.

Home Mode Zone: In home mode status, the system will not alarm once the sensor in home mode zone is triggered.

24-H Zone: In any condition, the system will alarm immediately once the 24-H zone detector is triggered.

How to set: Open the cover of the detector and change the array of jumpers to the corresponding zone position as below (Mind the direction of D0-D3).

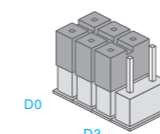

Normal Zone

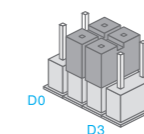

Home Mode Zone

Note: The default zone setting of PIR Motion Detector is Home Mode Zone. The default zone setting of Door/Window Contact is Normal Zone.

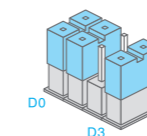

24-H Zone

It is recommended to set smoke detector, gas detector or IR beam sensors in 24-H zone which offer full-day detection.

Specifications

Power Supply

DC 12V 500mA

Backup Battery

18650 3.7V 1800mAh rechargeable lithium battery

Maximum Alarm Current

< 350mA

Static Current

< 14mA

Wireless Receiving Distance

< 80m (in open area)

Operation Condition

Temperature 0°C ~ +55°C

Relative Humidity < 80% (Non-condensing)

Maximum Siren Volume

105dB

Battery Standby Time

< 7 days

Radio Frequency

315MHz or 433.92MHz (±75KHz)

Housing Material

PC+ANTI-UV, ABS

IP Rating

IP54

Dimensions (L×W×H)

245.2 × 227.5 × 72.4 mm

CHUANGO®

产品型号	WS-280	部件名称	说明书
设计	林寿	材料	80克书写纸
印刷尺寸	420X285mm	成品尺寸	105X142.5mm
工艺	折页	版本	

注：
双色、双面印刷